

JVC

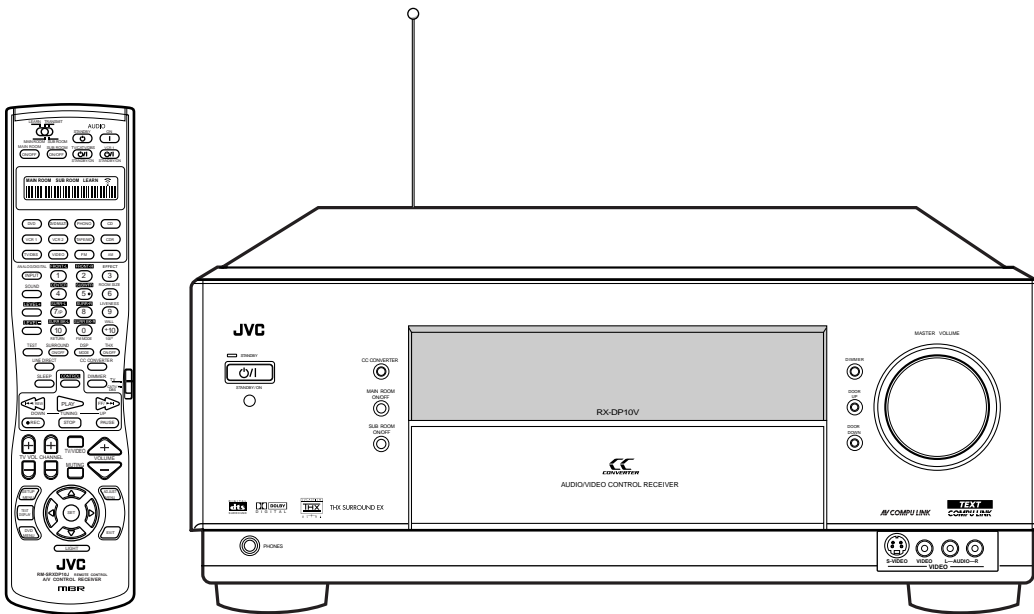

AUDIO/VIDEO CONTROL RECEIVER

RX-DP10VBK



AV/COMPU LINK

**TEXT
COMPU LINK**

DIGITAL
dts
SURROUND

DOLBY
DIGITAL

LUCASFILM
THX
ULTRA

THX SURROUND EX

INSTRUCTIONS

For Customer Use:

Enter below the Model No. and Serial No. which are located either on the rear, bottom or side of the cabinet. Retain this information for future reference.

Model No. _____

Serial No. _____

LVT0722-003A

[J]

Warnings, Cautions and Others



The lightning flash with arrowhead symbol, within an equilateral triangle is intended to alert the user to the presence of uninsulated "dangerous voltage" within the product's enclosure that may be of sufficient magnitude to constitute a risk of electric shock to persons.





The exclamation point within an equilateral triangle is intended to alert the user to the presence of important operating and maintenance (servicing) instructions in the literature accompanying the appliance.

WARNING: TO REDUCE THE RISK OF FIRE OR ELECTRIC SHOCK, DO NOT EXPOSE THIS APPLIANCE TO RAIN OR MOISTURE.

CAUTION

To reduce the risk of electrical shocks, fire, etc.:

1. Do not remove screws, covers or cabinet.
2. Do not expose this appliance to rain or moisture.

Caution —  (STANDBY/ON) switch!
Disconnect the mains plug to shut the power off completely. The  (STANDBY/ON) switch in any position does not disconnect the mains line. The power can be remote controlled.

Caution—SPEAKER LOAD SELECTOR switch!
Match the position of SPEAKER LOAD SELECTOR switch on the back panel to the impedance of the speaker connected, to protect from overheating.

CAUTION!
To avoid personal injury or accidentally dropping the unit, have two persons unpack, carry, and install the unit.
22.0 kg / 49.0 lb.

Note to CATV system installer:

This reminder is provided to call the CATV system installer's attention to Section 820-40 of the NEC which provides guidelines for proper grounding and, in particular, specifies that the cable ground shall be connected to the grounding system of the building, as close to the point of cable entry as practical.

For the main unit:

This equipment has been tested and found to comply with the limits for a Class B digital device, pursuant to part 15 of the FCC Rules. These limits are designed to provide reasonable protection against harmful interference in a residential installation.

This equipment generates, uses and can radiate radio frequency energy and, if not installed and used in accordance with the instructions, may cause harmful interference to radio communications. However, there is no guarantee that interference will not occur in a particular installation. If this equipment does cause harmful interference to radio or television reception, which can be determined by turning the equipment off and on, the user is encouraged to try to correct the interference by one or more of the following measures:

Reorient or relocate the receiving antenna.

Increase the separation between the equipment and receiver.

Connect the equipment into an outlet on a circuit different from that to which the receiver is connected.

Consult the dealer or an experienced radio/TV technician for help.

Changes or modifications not expressly approved by the manufacturer for compliance could void the user's authority to operate the equipment.

For the remote control:

This device complies with Part 15 of the FCC Rules. Operation is subject to the following two conditions: (1) This device may not cause harmful interference, and (2) this device must accept any interference received, including interference that may cause undesired operation.

Changes or modifications not expressly approved by the manufacturer for compliance could void the user's authority to operate the equipment.

Table of Contents

Introduction	2	■ Setting the Surround Sound Output—SURROUND SPEAKER	38
Features	2	■ Setting the Digital Input Terminals—DIGITAL IN	38
Precautions	2	■ Preparing for the Component Video Input—COMPONENT IN	39
Parts Identification	3	■ Turning On and Off the Video Output—VIDEO POWER ...	39
Getting Started	6	■ Preparing for the Sub-Room Operations—SUB ROOM	40
Before Installation	6	■ Showing the Text Information on the Display—FL DISPLAY	40
Checking the Supplied Accessories	6	■ Memorizing the Volume Level for Each Source—ONE TOUCH OPE(ration)	40
Connecting the FM and AM Antennas	6	Sound Adjustments	41
Connecting the Speakers	7	Adjustment Menu Configuration	41
Connecting Audio/Video Components	9	Operation through On-Screen Display Menus	42
■ Analog Connections	9	Menu Operating Procedure	43
■ Digital Connections	14	■ Adjusting the Speaker Channel Output Levels—LEVEL ...	44
Setting Up the RF Rod Antenna	15	■ Adjusting the Parametric Equalizer—PARAMETRIC EQ ...	44
Setting Up the IR Signal Transmitter	15	■ Adjusting the DSP Parameters—DSP PARAMETER	45
Connecting the Power Cord	16	■ Adjusting the Center Channel—CENTER CHANNEL	45
Putting Batteries in the Remote Control	16	Using the Surround Modes	46
Multi-Room Operations	17	Reproducing Theater Ambience	46
Required Connections for Sub-Room	17	Introducing the Surround Modes	46
Basic Operating Procedure for Main Room	18	Activating the Surround Modes	48
Basic Operating Procedure for Sub-Room	19	Adjusting the Surround Sounds Temporarily	49
Main Room Operations	20	Using the DSP Modes	50
Turning the Power On and Off (Standby)	20	Reproducing the Sound Field	50
Canceling the Main Room Operations	21	Introducing the DSP Modes	50
Selecting the Main Room Source to Play	21	Activating the DSP Modes	51
Adjusting the Main Room Volume	22	Adjusting the DSP Parameters Temporarily	52
Activating the Main Room Front Speakers	23	Using the DVD MULTI Playback Mode	53
Selecting the Analog or Digital Input Mode	23	Activating the DVD MULTI Playback Mode	53
Attenuating the Input Signal	24	COMPU LINK Remote Control System	54
Muting the Main Room Sound	24	TEXT COMPU LINK Remote Control System ..	56
Changing the Display Brightness	25	■ Showing the Disc Information on the TV Screen (Either in the Main Room or in the Sub-Room)	57
Turning Line Direct On and Off	25	■ Searching for a Disc (Only for the CD player)	58
Making Sounds Natural	25	■ Entering the Disc Information	59
Changing the Source Name	25	AV COMPU LINK Remote Control System ...	61
Using the Sleep Timer	26	Operating JVC's Audio/Video Components ...	64
Sub-Room Operations	27	Operating Audio Components	64
Turning the Power On and Off (Standby) and Selecting the Sub-Room Operations	27	Operating Video Components	66
Canceling the Sub-Room Operations	28	Operating Other Manufacturers' Equipment ...	67
Selecting the Sub-Room Source to Play	29	Changing the Preset Signal Codes	67
Adjusting the Sub-Room Volume	29	Storing the Remote Signals Manually	71
Activating the Sub-Room Front Speakers	30	Troubleshooting	74
Muting the Sub-Room Sound	30	Specifications	76
Receiving Radio Broadcasts	31		
Tuning into Stations Manually	31		
Using Preset Tuning	32		
Selecting the FM Reception Mode	32		
Basic Settings	33		
Setup Menu Configuration	33		
Operation through On-Screen Display Menus	34		
Menu Operating Procedure	35		
■ Setting the Speakers—SPEAKER SETTING	36		
■ Setting the Speaker Distance—SPEAKER DISTANCE	36		
■ Setting the Bass Sounds—SUBWOOFER	37		
■ Setting the Dynamic Range—DYNAMIC RANGE	38		
■ Preparing for THX Surround Modes—THX	38		



Indicates the functions YOU CAN ALSO USE when the receiver is ready for the sub-room operations.

Introduction

*We would like to thank you for purchasing one of our JVC products.
Before operating this unit, read this manual carefully and thoroughly to obtain the best possible performance
from your unit, and retain this manual for future reference.*

Features

THX Surround EX (DTS-ES compatible)

THX Surround EX is a format that has additional left and right surround back channels on the basis of Dolby Digital 5.1 channels. It improves the definition and the sense of sound movement in surround (rear) channels.

- This receiver is also compatible with DTS Extended Surround (DTS-ES)—another multichannel surround containing additional left and right surround back channels.

7.1 channel DAP (Digital Acoustic Processor)

Sound field simulation technology allows precise ambience recreation of existing theaters and halls. Thanks to the high-performance DSP (Digital Signal Processor) and high-capacity memory, you can enjoy 7.1-channel surround by playing 2-channel or multichannel software.

Multichannel headphone virtual surround sound—3D HEADPHONE

The built-in headphone virtual surround system is compatible with multichannel software like Dolby Digital, DTS Surround, etc. Thanks to the new signal processing algorithms used by the high-performance DSP, you can enjoy a natural surround sound through the headphones.

192 kHz/24 bit PEM DD audio DA converter

The JVC-exclusive converter is now upgraded to be fully compatible with DVD Audio's high specifications. Subtle nuances are accurately reproduced.

CC (Compensative Compression) converter

CC Converter eliminates jitter and ripples, achieving a drastic reduction in digital distortion by processing the digital music data in 24 bit-quantization and by expanding the sampling frequency to 176.4 kHz (for fs 44.1 kHz signals)/192 kHz (for fs 48 kHz signals). By using the CC Converter, you can obtain a natural sound field from any source.

Multi-room operations

You can connect two pairs of front speakers to the RX-DP10VBK, and use them to listen to different sources in the different rooms (Main room and Sub-room) at the same time.

RF/IR multi-brand/learning remote control

The remote control sends out not only IR (infrared) signals but also RF (radio frequency) signals as coded commands to control the receiver. The RF rod antenna can receive the RF signals sent from the remote control to operate the receiver. In addition, the supplied IR signal transmitter can transmit IR signals which can control other video components.

- The remote control provided for this receiver can transmit control signals for many manufacturers' components, and can learn and store any signals.

COMPU LINK/TEXT COMPU LINK/AV COMPU LINK remote control systems

These COMPU LINK remote control systems allow you to operate other JVC audio/video components from this receiver.

Precautions

Power sources

- When unplugging the receiver from the wall outlet, always pull the plug, not the AC power cord.
- Do not handle the AC power cord with wet hands.
- If you are not going to operate the receiver for an extended period of time, unplug the AC power cord from the wall outlet.

Multi-room operations

- Do not use the remote control outdoors or install the speakers outdoors.
- When operating the receiver from the place where you cannot see the receiver (for example, when controlling the receiver installed in the living room from the kitchen), pay attention to the following not to surprise other people:
 - Be careful not to turn up the volume so high when controlling the receiver without listening to the playback sound.
 - Be careful not to surprise other people with a sudden sound coming out of the receiver when turning it on. (A sudden stop of the sound may also surprise other people.)
- If the receiver operates by itself or malfunctions, the following causes will be considered:
 - Interference to RF communication between the receiver and the remote control from outside.
 - The remote control is operated unintentionally. For example, a book is placed on the remote control, possibly, depressing some buttons on the remote control.
- If your neighbour uses the same or similar RF remote control system, the receiver may happen to receive the RF signals sent from such an RF remote control system, which could cause your receiver to be operated unintentionally. If this happens, set the BAND selectors both on the rear and on the remote control to another band (either BAND 1 or BAND 2)—see page 15 for details.
If the problem still persists, stop using the RF rod antenna and the remote control, and consult your JVC dealer or the nearest JVC Service Center.

Ventilation

Seven high power amplifiers built in this receiver will generate heat inside the cabinet. When the temperature inside the cabinet increases, the internal fan automatically starts rotating to reduce the internal temperature. For safety, observe the following carefully.

- Make sure there is good ventilation around the receiver. Poor ventilation could overheat and damage the receiver.
- Do not block the ventilation openings or holes. (If the ventilation openings or holes are blocked by a newspaper or cloth, etc., the heat may not be able to get out.)

Others

- Should any metallic object or liquid fall onto the unit, unplug the unit and consult your dealer before operating any further.
- Do not use this receiver in a bathroom or places with water.
- Do not place any containers filled with water or liquids (such as cosmetics or medicines, flower vases, potted plants, cups, etc.) on top of this receiver.
- Do not disassemble the unit since there are no user serviceable parts inside.

If anything goes wrong, unplug the AC power cord and consult your JVC dealer.

Parts Identification

Front Panel

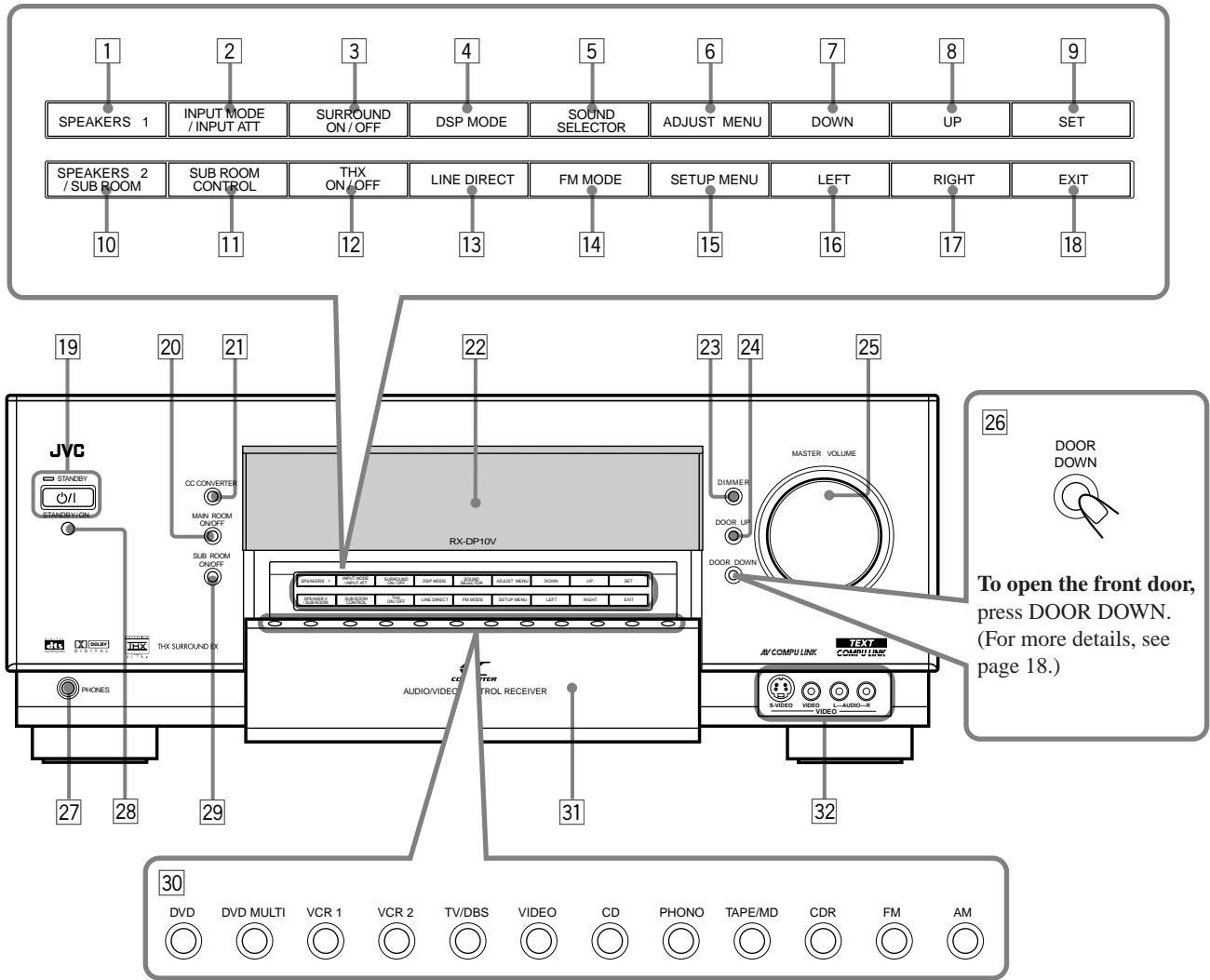

Display Window

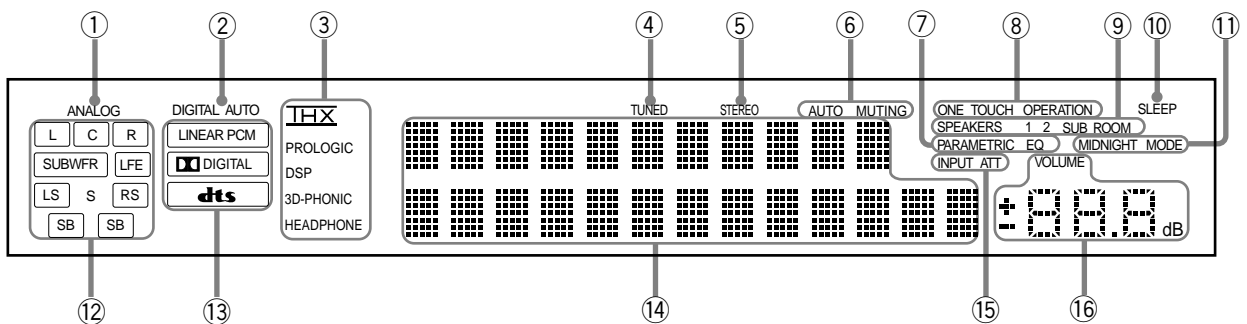

Refer to the pages in parentheses for details.

Front Panel

- 1 **SPEAKERS 1 button (18, 23)**
- 2 **INPUT MODE/INPUT ATT button (23, 24)**
- 3 **SURROUND ON/OFF button (48)**
- 4 **DSP MODE button (51)**
- 5 **SOUND SELECTOR button (22)**
- 6 **ADJUST MENU button (42)**
- 7 **DOWN button (31, 34, 42)**
- 8 **UP button (31, 34, 42)**
- 9 **SET button (32, 34, 42)**
- 10 **SPEAKERS 2/SUB ROOM button (18, 23, 30)**
- 11 **SUB ROOM CONTROL button (19, 27)**
- 12 **THX ON/OFF button (48)**
- 13 **LINE DIRECT button (25)**
- 14 **FM MODE button (32)**
- 15 **SETUP MENU button (34)**
- 16 **LEFT button (32, 34, 42)**
- 17 **RIGHT button (32, 34, 42)**
- 18 **EXIT button (34, 42)**
- 19 **⏻/I (STANDBY/ON) button and STANDBY lamp (18, 19, 20, 27)**
 - STANDBY lamp lights up in red when main room is turned on.
- 20 **MAIN ROOM ON/OFF button and lamp (21)**
 - MAIN ROOM ON/OFF lamp lights up in red when main room is turned on.
- 21 **CC CONVERTER button and lamp (25)**
 - CC CONVERTER lamp lights up in red when CC Converter is turned on.
- 22 **Display**
- 23 **DIMMER button (25)**
- 24 **DOOR UP button (18)**
- 25 **MASTER VOLUME control (18, 19, 22, 29)**
- 26 **DOOR DOWN button (18)**
- 27 **PHONES jack (23)**
- 28 **Remote sensor**
- 29 **SUB ROOM ON/OFF button and lamp (19, 27)**
 - SUB ROOM ON/OFF lamp lights up in red when sub-room is turned on.
- 30 **Source selecting buttons (18, 19, 21, 29)**
 - DVD, DVD MULTI, VCR 1, VCR 2, TV/DBS, VIDEO, CD, PHONO, TAPE/MD, CDR, FM, AM
- 31 **Front door**
- 32 **VIDEO input terminals (11)**

Display Window

- 1 **ANALOG indicator (24)**
 - Lights up when an analog input (source) is selected.
- 2 **DIGITAL AUTO indicator (24)**
 - Lights up when auto digital input (DIGITAL AUTO) is selected.
- 3 **Surround/DSP mode indicators**
 - Indicate the current Surround/DSP mode setting.
- 4 **TUNED indicator (31)**
 - Lights up when a station is received.
- 5 **STEREO indicator (31)**
 - Lights up when an FM stereo station is received.
- 6 **AUTO MUTING indicator (32)**
 - Lights up when the FM station reception mode is set to Auto Reception mode (AUTO MUTING).
- 7 **PARAMETRIC EQ indicator (45)**
 - Lights up when Parametric Equalizer is in use.
- 8 **ONE TOUCH OPERATION indicator (40)**
 - Lights up when One Touch Operation is in use.
- 9 **SPEAKERS 1/2/SUB ROOM indicators (18, 23, 30)**
 - SPEAKERS: Lights up when any of the speakers connected to the FRONT 1 SPEAKERS and the FRONT 2/SUB ROOM SPEAKERS terminals is activated.
 - 1/2: Lights up when the corresponding speakers are activated for the main room.
 - SUB ROOM: Lights up when the front speakers connected to the SPEAKERS 2/SUB ROOM terminals are activated for the sub-room.
- 10 **SLEEP indicator (26)**
 - Lights up when Sleep Timer is in use.
- 11 **MIDNIGHT MODE indicator (38)**
 - Lights up when Midnight Mode is in use.
- 12 **Speaker indicators and signal indicators (21)**
 - Speaker indicators: Indicate the activated speakers.
 - Signal indicators: Indicate the incoming channel signals.
- 13 **Digital signal format indicators (24)**
 - Indicates the digital signal format of incoming signals.
- 14 **Main display**
 - Shows the source name, station frequency, Surround/DSP mode, etc.
- 15 **INPUT ATT indicator (24)**
 - Lights up when Input Attenuator is in use.
- 16 **VOLUME level indicator**
 - Indicates the volume level.
 - Goes off while muting sounds.

Remote Control

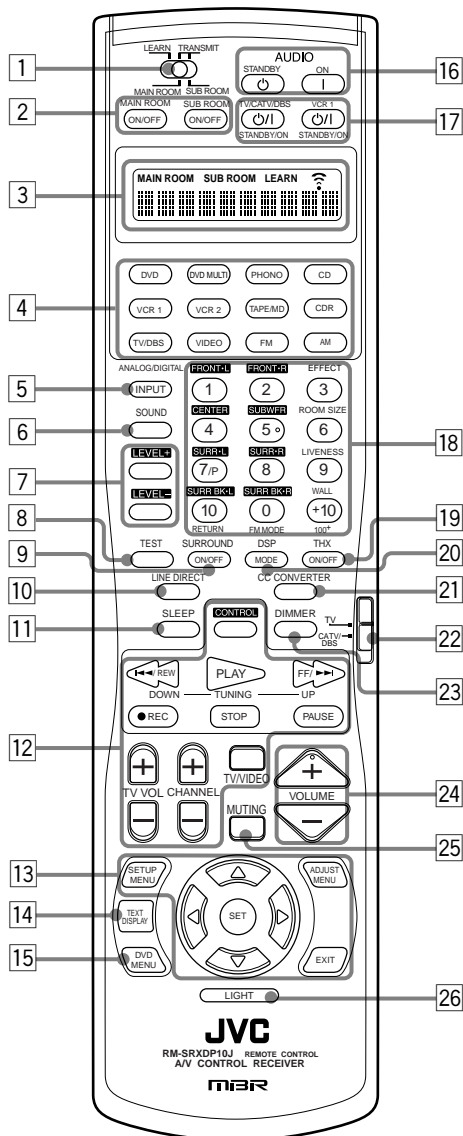

Remote's display window

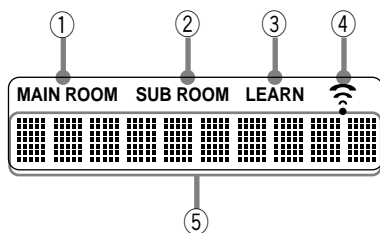

- 1 MAIN ROOM/SUB ROOM (LEARN/TRANSMIT) selector
- 2 MAIN ROOM ON/OFF button (21)
SUB ROOM ON/OFF button (28)
- 3 Display window
- 4 Source selecting buttons (18, 19, 21, 29)
 - DVD, DVD MULTI, PHONO, CD, VCR 1, VCR 2, TAPE/MD, CDR, TV/DBS, VIDEO, FM, AM

- 5 ANALOG/DIGITAL INPUT button (23)
- 6 SOUND button (49, 52, 64)
- 7 LEVEL +/- buttons (49, 64)
- 8 TEST button (49, 64)
- 9 SURROUND ON/OFF button (48, 64)
- 10 LINE DIRECT button (25)
- 11 SLEEP button (26)
- 12 Operating buttons for audio/video components (31, 64 – 69, 71 – 73)
- 13 On-screen operation buttons (34, 42, 57)
 - SETUP MENU, ADJUST MENU, SET, EXIT, Δ (UP), ∇ (DOWN), ◀ (LEFT), ▶ (RIGHT)
- 14 TEXT DISPLAY button (57)
- 15 DVD MENU button (66, 69)
- 16 AUDIO buttons
 - STANDBY (⏻), ON (⏻) (18, 19, 20, 28)
- 17 TV/CATV/DBS STANDBY/ON (⏻/⏻) button (66 – 68)
VCR 1 STANDBY/ON (⏻/⏻) (66, 68, 69)
- 18
 - 10 keys for selecting preset channels (32)
 - 10 keys for adjusting sound (49)
 - 10 keys for adjusting DSP parameters (52)
 - 10 keys for operating audio/video components (64 – 73)
- 19 THX ON/OFF button (48)
- 20 DSP MODE button (51)
- 21 CC CONVERTER button (25)
- 22 TV operation mode selector (TV or CATV/DBS) (66 – 68, 72)
- 23 DIMMER button (25)
- 24 VOLUME +/- buttons (18, 19, 22, 29)
- 25 MUTE button (24, 30)
- 26 LIGHT button (16)

Remote's display window

- 1 MAIN ROOM indicator
 - Lights up when you press a button on the remote control, with the MAIN ROOM/SUB ROOM (LEARN/TRANSMIT) selector is set to "MAIN ROOM." In this case, this remote control can be used only for main room operations.
- 2 SUB ROOM indicator
 - Lights up when you press a button on the remote control, with the MAIN ROOM/SUB ROOM (LEARN/TRANSMIT) selector set to "SUB ROOM." In this case, this remote control can be used only for sub-room operations.
- 3 LEARN indicator
 - Lights up when you press a button on the remote control, with the MAIN ROOM/SUB ROOM (LEARN/TRANSMIT) selector set to "LEARN." In this case, this remote control cannot operate the receiver or other components, but can memorize IR signals.
- 4 Signal transmission indicator
 - Lights up when transmitting the remote control signals.
- 5 Remote control operation mode display
 - Remote control operation mode such as "DVD," "CD," "SOUND," etc. appears.
 - When the remote control operation mode changes, it is shown on this display for about 10 seconds. (When showing the remote control operation mode just for confirmation, it is shown only for about 5 seconds—i.e. when pressing Number button 1 while the remote control operation mode is "CD," "CD" appears for about 5 seconds.)

Getting Started

This section explains how to connect audio/video components and speakers to the receiver, and how to connect the power supply.

Before Installation

General

- Be sure your hands are dry.
- Turn the power off on all components.
- Read the manuals supplied with the components you are going to connect.

Location

- Install the receiver in a location that is level, well-ventilated and free from moisture.
- The temperature around the receiver must be between -5°C and 35°C (23°F and 95°F).
- Make sure there is good ventilation around the receiver. Poor ventilation could overheat and damage the receiver.

Handling the receiver

- Do not insert any metal object into the receiver.
- Do not disassemble the receiver or remove screws, covers, or cabinet.
- Do not expose the receiver to rain or moisture.

Checking the Supplied Accessories

Check to be sure you have all of the following items, which are supplied for the receiver.

The number in the parentheses indicates quantity of the pieces supplied.

- Remote Control (1)
- Batteries (2)
- AM Loop Antenna (1)
- FM Antenna (1)
- RF Rod Antenna (1)
- IR Signal Transmitter (1)
- Double-Sided Adhesive Tape (1)
- Front Terminal Cover (1)

If any item is missing, contact your dealer immediately.

Connecting the FM and AM Antennas

FM Antenna Connections

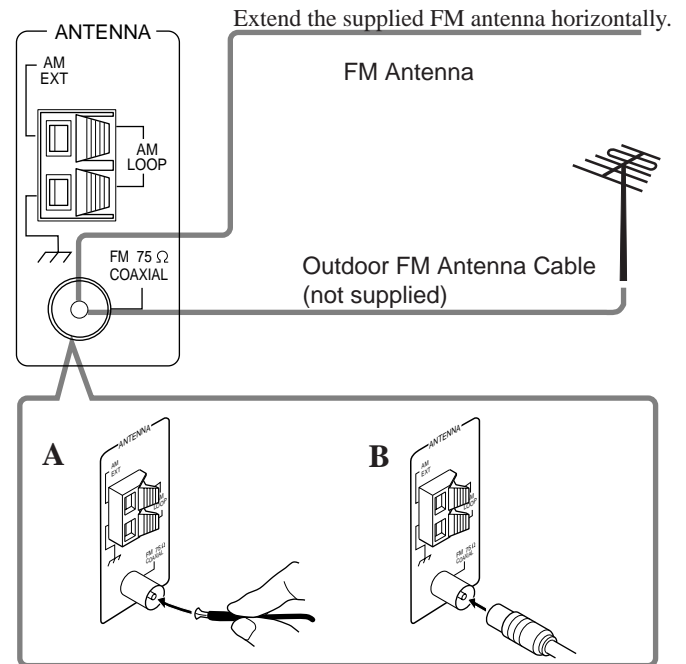

A. Using the Supplied FM Antenna

The FM antenna provided can be connected to the FM 75Ω COAXIAL terminal as a temporary measure.

B. Using the Standard Type Connector with Outdoor FM Antenna (not Supplied)

A standard type connector should be connected to the FM 75Ω COAXIAL terminal.

Note:

If reception is poor, connect the outdoor antenna. Before attaching a 75Ω coaxial cable (the kind with a round wire going to an outdoor antenna), disconnect the supplied FM antenna.

AM Antenna Connections

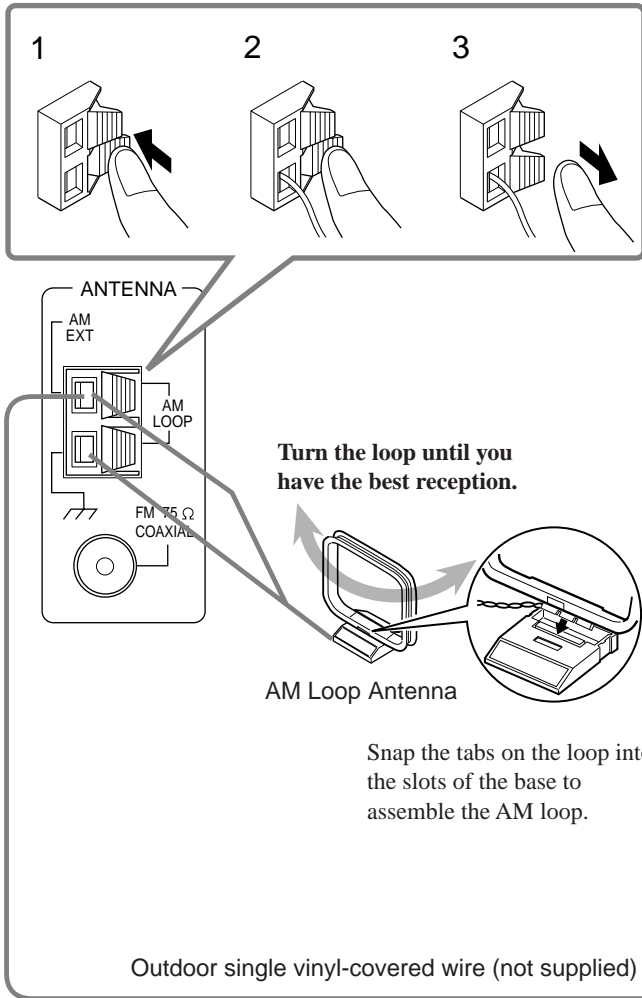

Notes:

- If the AM loop antenna wire is covered with vinyl, remove the vinyl by twisting it as shown in the diagram.
- Make sure the antenna conductors do not touch any other terminals, connecting cords and power cord. This could cause poor reception.
- If reception is poor, connect an outdoor single vinyl-covered wire to the AM EXT terminal. (Keep the AM loop antenna connected.)



Connecting the Speakers

You can connect the following speakers:

- Two pairs of front speakers to produce normal stereo sound.
- One pair of surround speakers to enjoy the surround effect.
- One pair of surround back speakers to enjoy 7.1 channel sound reproduction.
- One center speaker to produce more effective surround effect (to emphasize human voices).
- One powered subwoofer to enhance the bass.

IMPORTANT:

After connecting the speakers listed above, set the speaker setting information properly:

- To obtain the best possible Surround and DSP effect in the main room, see “Basic Settings” on pages 33 to 40.
- To use the Multi-room function, see “Preparing for the Sub-Room Operations—SUB ROOM” on page 40.

For each speaker (except for a subwoofer), connect the (+) and (–) terminals on the rear panel to the (+) and (–) terminals marked on the speakers. For connecting a subwoofer, see page 8.

CAUTION:

Use speakers with the SPEAKER IMPEDANCE indicated by the speaker terminals.

Main room speaker layout

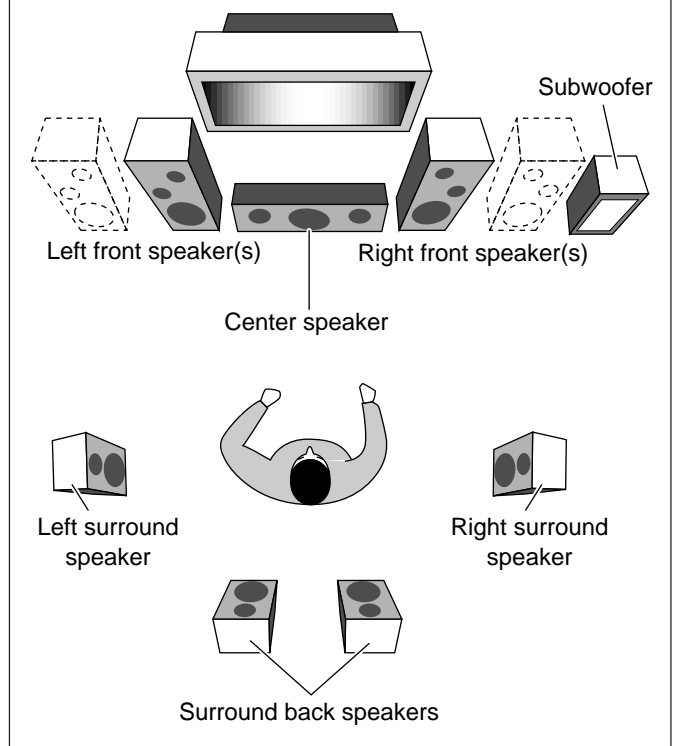

Note:

When connecting the speakers for the sub-room, see also page 17.

Basic connecting procedure

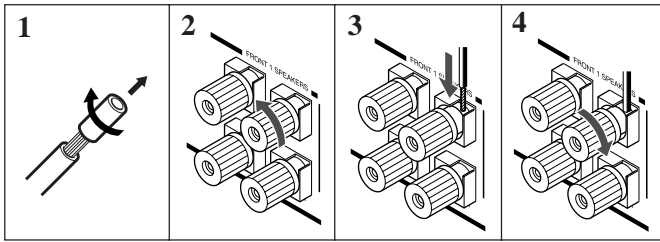

- 1 Cut, twist and remove the insulation at the end of each speaker signal cable (not supplied).
- 2 Turn the knob counterclockwise.
- 3 Insert the speaker signal cable.
- 4 Turn the knob clockwise.

Note:

You can connect two pairs of front speakers—one pair to the **FRONT 1 SPEAKERS** terminals, and the other pair to the **FRONT 2 / SUB ROOM SPEAKERS** terminals.

The speakers connected to the **FRONT 2 / SUB ROOM SPEAKERS** terminals can be used as follows:

- As the second front speakers in the main room
- As the front speakers in the sub-room when using the Multi-room operations. (See page 17.)

CAUTION:

Use only the speakers of the **SPEAKER IMPEDANCE** indicated by the speaker terminals.

IMPORTANT for the FRONT 1 SPEAKERS connection:

To obtain the best possible output power from the receiver, and to prevent the receiver from being overheated, the receiver has the **SPEAKER LOAD SELECTOR** which has to be set as follows:

- Set it to the “HIGH” position when the impedance of the front speakers connected is within the range of 8 Ω to 16 Ω.
- Set it to the “LOW” position when the impedance of the front speakers connected is within the range of 4 Ω to 6 Ω.

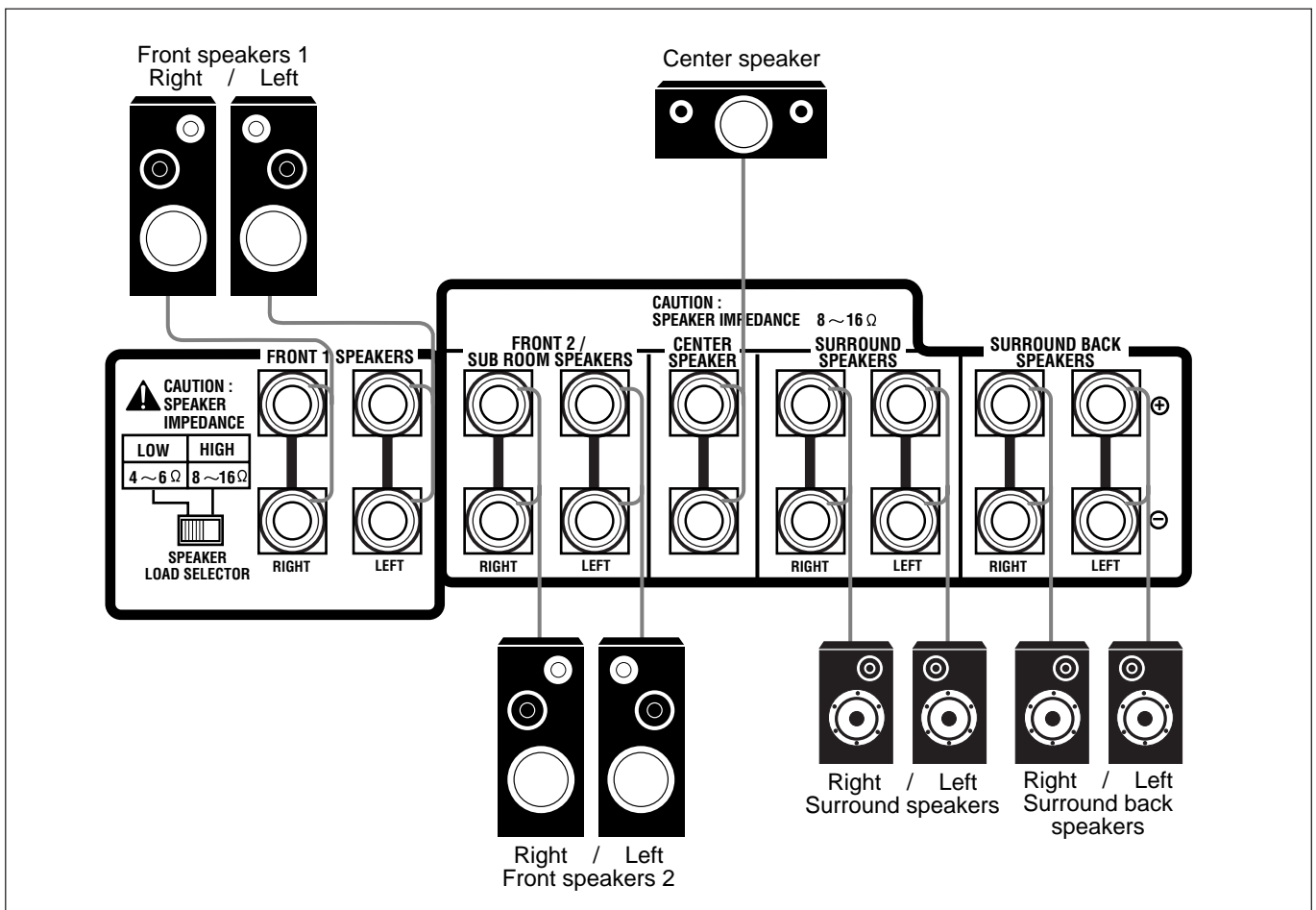

Connecting a subwoofer

You can enhance the bass by connecting a subwoofer. Connect the input jack of a powered subwoofer to the **SUBWOOFER PREOUT** jack on the rear panel, using a cable with RCA pin plugs (not supplied).

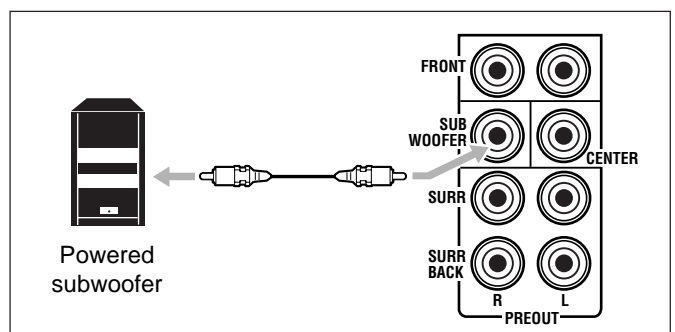

Enhance your audio system

You can use this receiver as the pre-amplifier (control amplifier) when you connect power amplifiers to the PREOUT jacks on the rear panel, using cables with RCA pin plugs (not supplied).

- Connect the white plug to the audio left jack, and the red plug to the audio right jack.

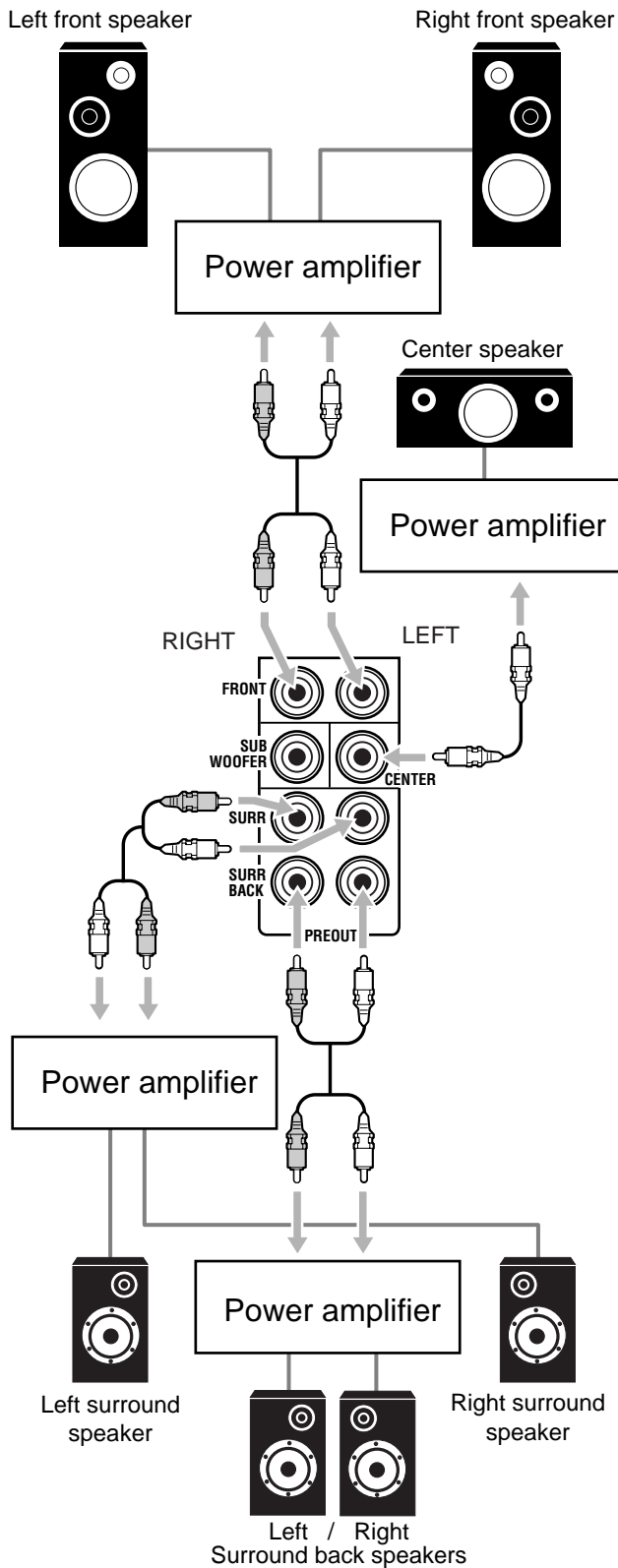

Connecting Audio/Video Components

You can connect the following audio/video components to this receiver. Refer also to the manuals supplied with your components.

Audio Components	Video Components
• Turntable	• DVD player*
• CD player*	• TV*
• Cassette deck or MD recorder*	• DBS tuner*
• CD recorder*	• VCRs (VCR1* and VCR2)
	• Video camera

* You can connect these components using the methods described in "Analog connections" (below) and in "Digital connections" (see page 14).

Analog Connections

Audio component connections

Use the cables with RCA pin plugs (not supplied).

- Connect the white plug to the audio left jack, and the red plug to the audio right jack.

CAUTION:

If you connect a sound-enhancing device such as a graphic equalizer between the source components and this receiver, the sound output through this receiver may be distorted.

Turntable

If a ground cable is provided for your turntable, connect the cable to the screw marked (⊕) on the rear panel.



Turntable To audio output

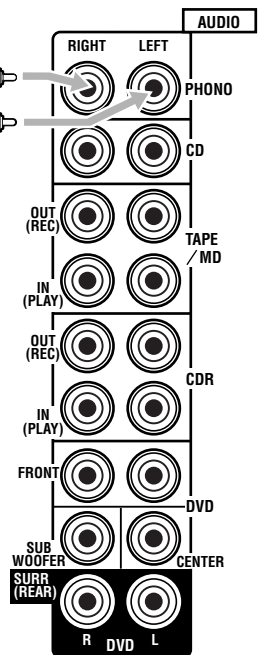

Note:

The above connection is for a turntable with an MM (moving-magnet) type cartridge.

Any turntables incorporating a small-output cartridge such as an MC (moving-coil) type must be connected to this receiver through a commercial head amplifier or step-up transformer. Direct connection may result in insufficient volume.

CD player

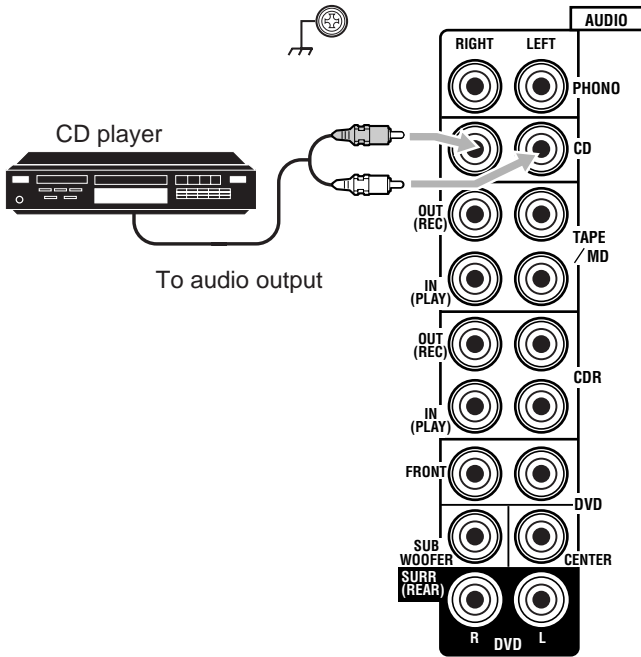

CD recorder

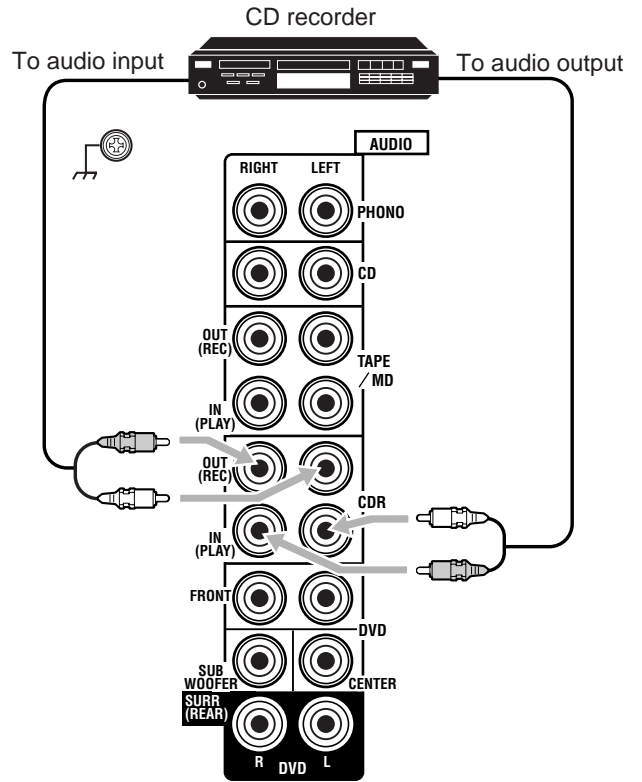

Cassette deck or MD recorder

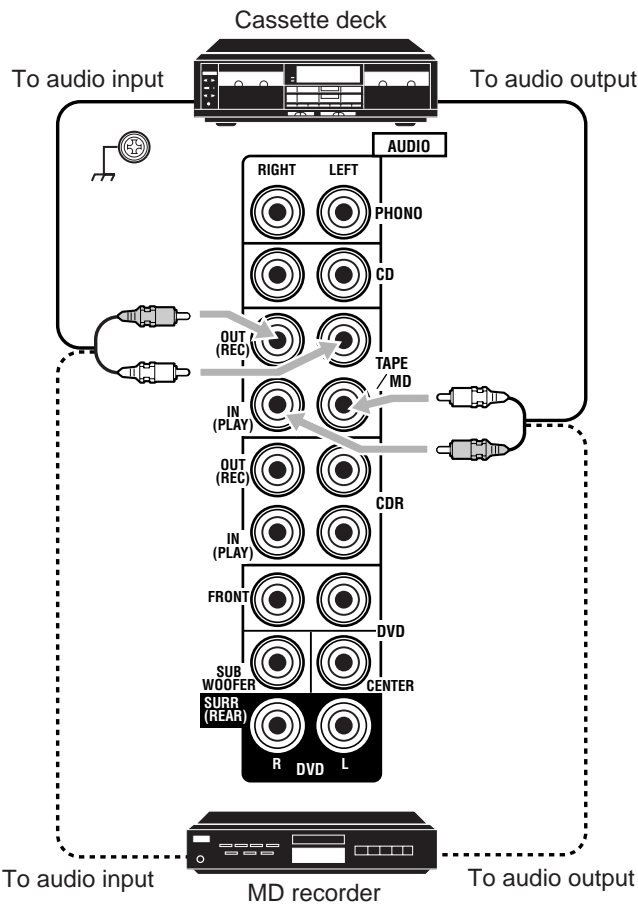

If your audio components have a COMPU LINK or TEXT COMPU LINK jack

- See page 54 for detailed information about the connection and the COMPU LINK remote control system.
- See page 56 for detailed information about the connection and the TEXT COMPU LINK remote control system.

Note:

You can connect either a cassette deck or an MD recorder to the TAPE/MD jacks. When connecting an MD recorder to the TAPE/MD jacks, change the source name to "MD," which will be shown on the display when selected as the source. See "Changing the Source Name" on page 25 for details.

Video component connections

Use the cables with RCA pin plugs (not supplied).

Connect the white plug to the audio left jack, the red plug to the audio right jack, and the yellow plug to the video jack.

- If your video components have S-video (Y/C-separation) and/or component video (Y, Pb/Cb, Pr/Cr) jacks, connect them using an S-video cable (not supplied) and/or component video cable (not supplied). By using these jacks, you can get a better picture quality—in the order: Component video > S-video > Composite video.

IMPORTANT:

This receiver is equipped with the following video jacks—composite video, S-video and component video jacks. You can use any of the three to connect a video component.

However, **the video signals from one type of these input jacks are output only through the video output jacks of the same type.**

Therefore, if a recording video component and a playing video component are connected to the receiver through the video jacks of the different type, you cannot record the picture. In addition, if the TV and a playing video component are connected to the receiver through the video jacks of the different type, you cannot view the playback picture on the TV.

VCR(s)

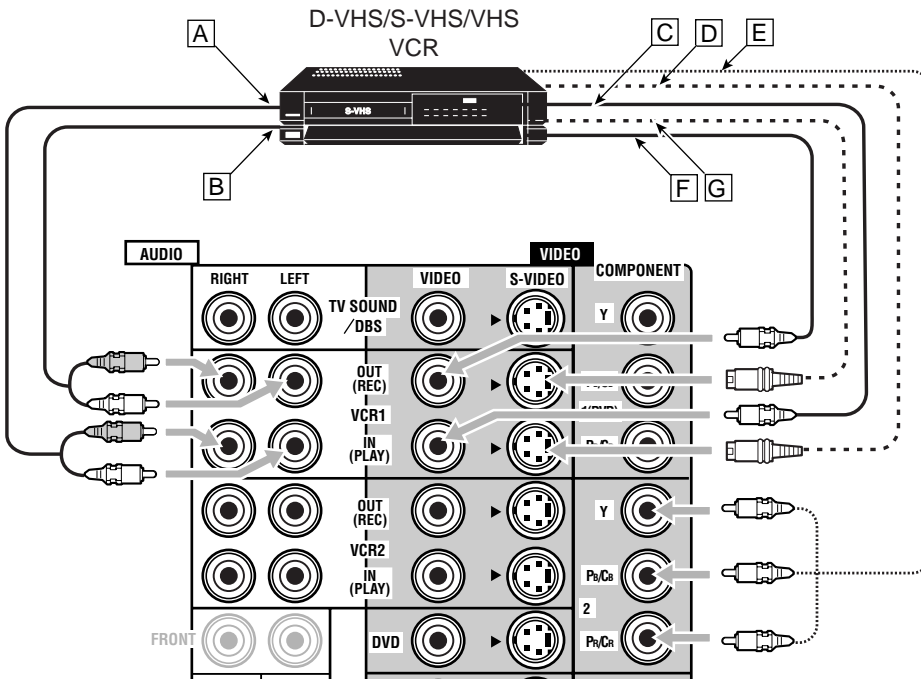

- A To audio output
- B To audio input
- C To composite video output
- D To S-video output
- E To component video output
- F To composite video input
- G To S-video input

Note:

If your VCR has the component video output jacks, you can connect it to either the COMPONENT 1 (DVD) or the COMPONENT 2 jacks. When connecting a VCR to either one of the component input jacks, make the component input (COMPONENT) terminal setting correctly. For details, see "Preparing for the Component Video Input—COMPONENT IN" on page 39.

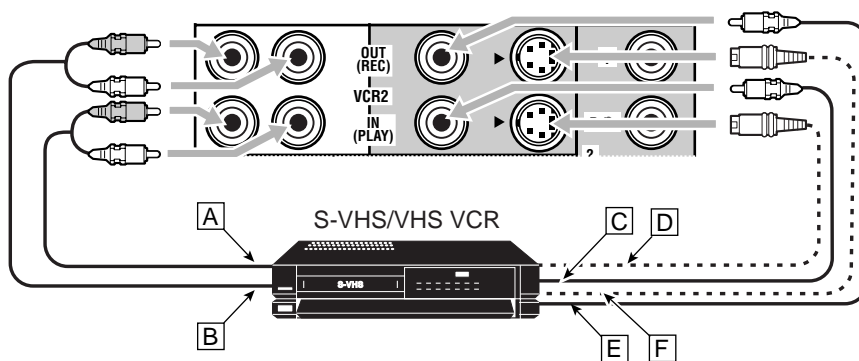

- A To audio output
- B To audio input
- C To composite video output
- D To S-video output
- E To composite video input
- F To S-video input

Video camera

The VIDEO input jacks on the front panel are convenient when connecting and disconnecting the component frequently.

- When you do not use the VIDEO input jacks, attach the front terminal cover (supplied) to these jacks to protect them from dust.

- When attaching the cover
- When removing the cover

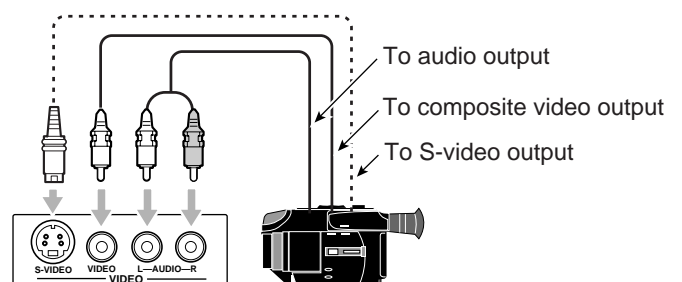
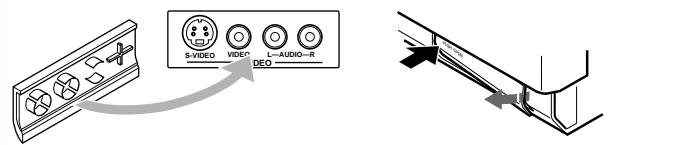

TV and/or DBS tuner

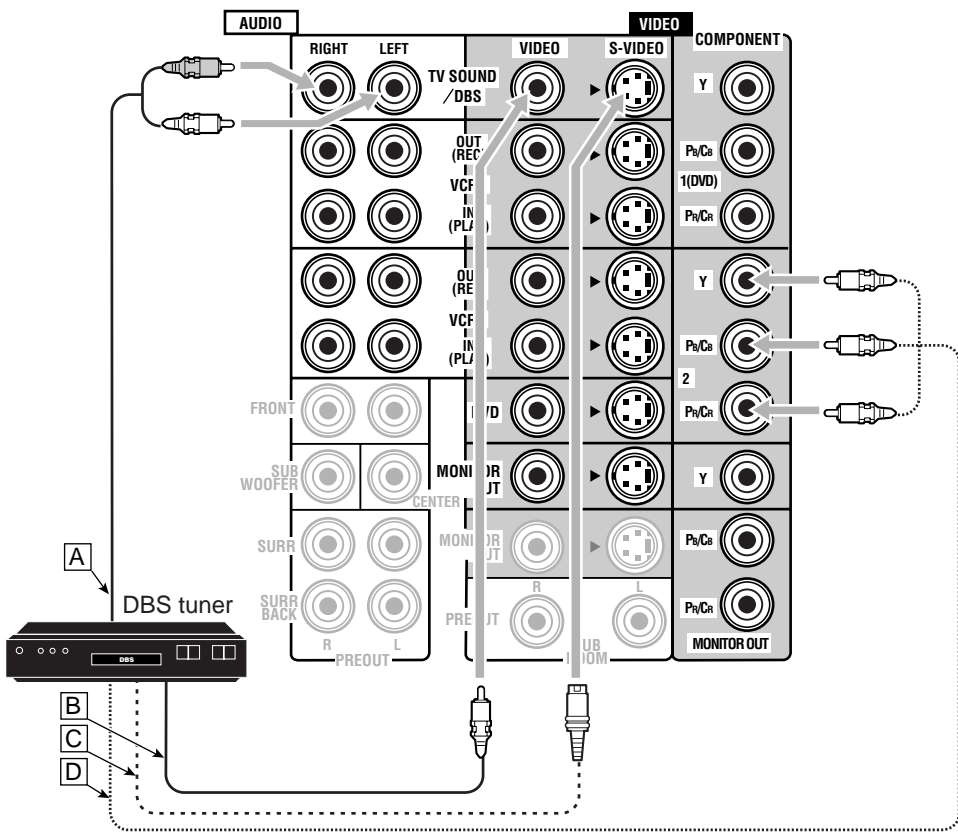
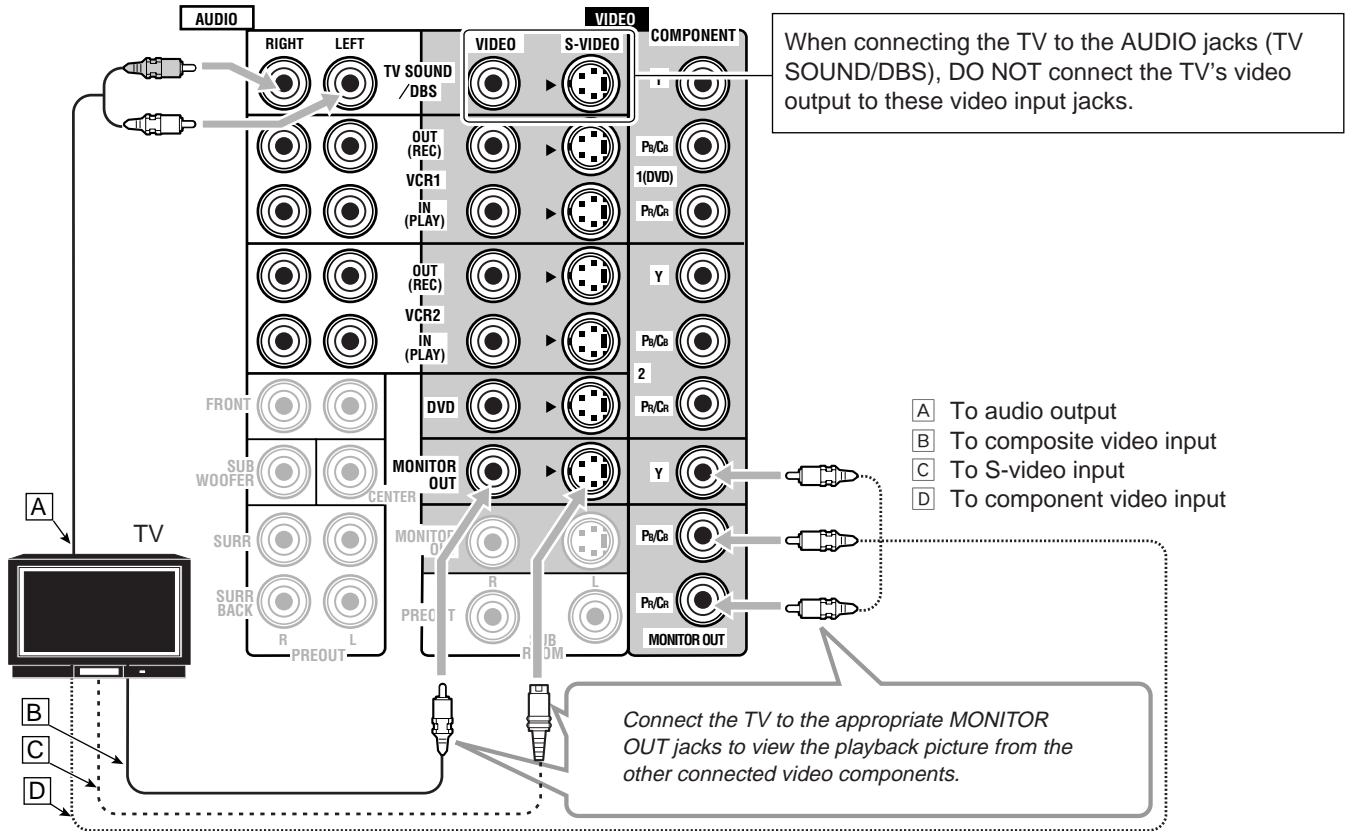

Notes:

- When connecting the DBS tuner to the TV SOUND/DBS jacks, change the source name to "DBS," which will be shown on the display when selected as the source. See "Changing the Source Name" on page 25 for details.
- If your DBS tuner has the component video output jacks, you can connect it to either the COMPONENT 1 (DVD) or the COMPONENT 2 jacks. When connecting the DBS tuner to either one of the component input jacks, make the component input (COMPONENT) terminal setting correctly. For details, see "Preparing for the Component Video Input—COMPONENT IN" on page 39.

- A To audio output
- B To composite video output
- C To S-video output
- D To component video output

DVD player

- When you connect the DVD player with stereo output jacks:

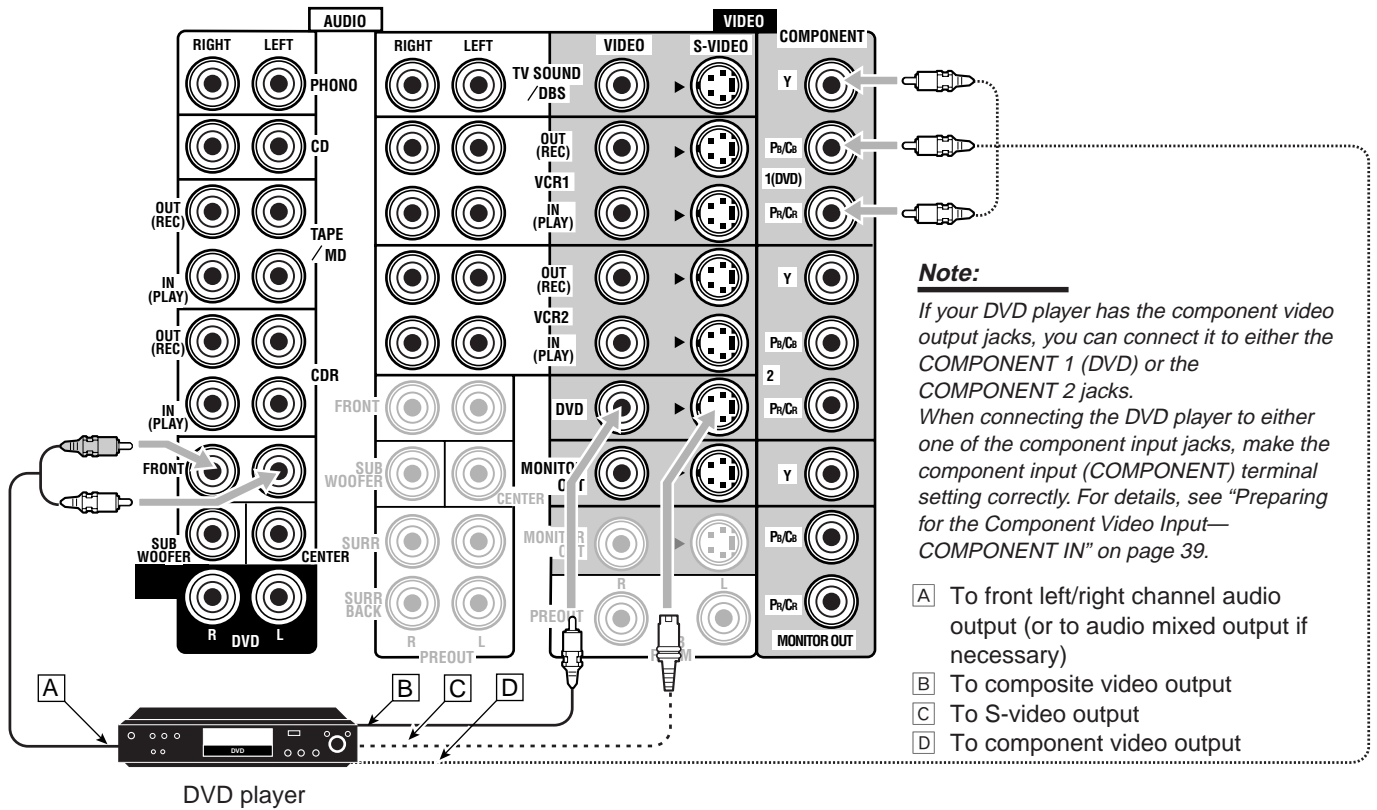

- When you connect the DVD player with its analog discrete output (5.1 CH reproduction) jacks:

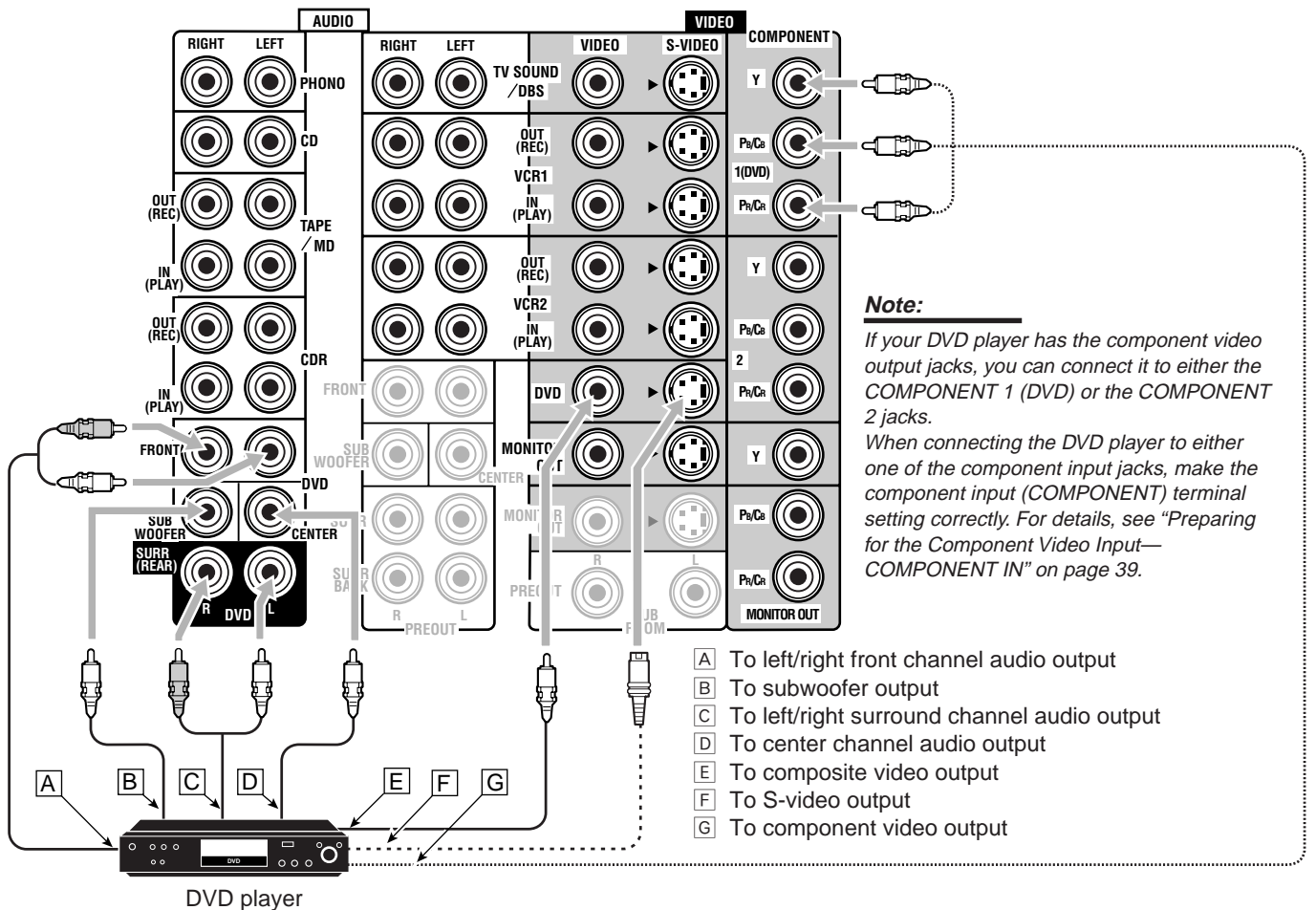

Digital Connections

This receiver is equipped with five DIGITAL IN terminals—one digital coaxial terminal and four digital optical terminals—and one DIGITAL OUT terminal.

IMPORTANT:

- When connecting the DVD player, digital TV broadcast tuner, digital VCR, or DBS tuner using the digital terminals, you also need to connect it to the video terminal on the rear. Without connecting it to the video terminal, you cannot view any playback picture.
- After connecting the components using the DIGITAL IN terminals, set the following correctly if necessary.
 - Set the digital input (DIGITAL IN) terminal setting correctly. For details, see "Setting the Digital Input Terminals—DIGITAL IN" on page 38.
 - Select the digital input mode correctly. For details, see "Selecting the Analog or Digital Input Mode" on page 23.

Digital input terminals

You can connect any digital component as follows:

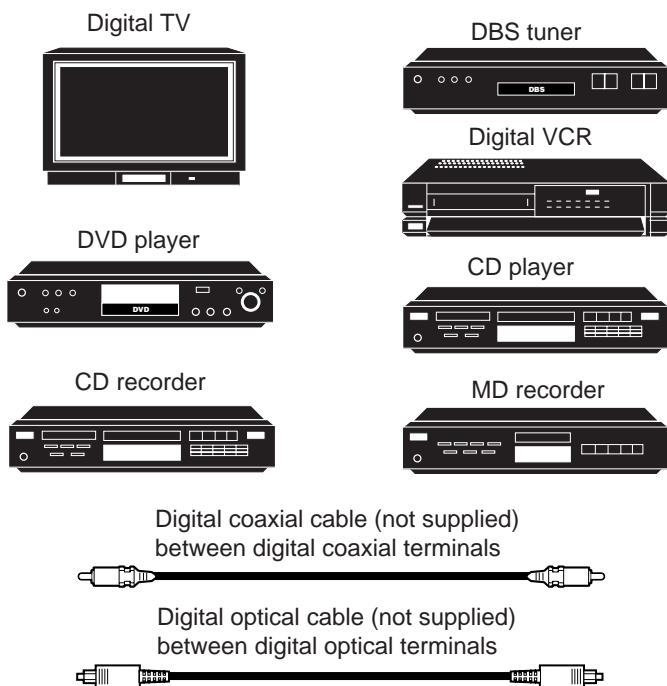

When the component has a digital coaxial output terminal, connect it to the DIGITAL 1 (DVD) terminal, using the digital coaxial cable (not supplied).

When the component has a digital optical output terminal, connect it to the DIGITAL 2 (CD), DIGITAL 3 (TV), DIGITAL 4 (CDR), or DIGITAL 5 (MD) terminal, using the digital optical cable (not supplied).

Before connecting a digital optical cable, unplug the protective plug.

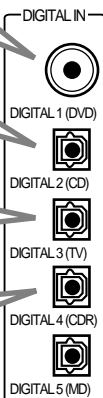
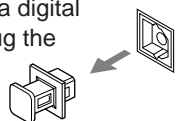

Notes:

- When shipped from the factory, the DIGITAL IN terminals have been set for use with the following components:
 - DIGITAL 1 (coaxial): For DVD player
 - DIGITAL 2 (optical): For CD player
 - DIGITAL 3 (optical): For digital TV broadcast tuner
 - DIGITAL 4 (optical): For CD recorder
 - DIGITAL 5 (optical): For MD recorder
- When you want to operate the CD player, CD recorder, or MD recorder using the COMPU LINK remote control system, connect the target component also as described in "Analog connections" (see page 10).
- When you want to operate the VCR or DVD player using the AV COMPU LINK remote control system, connect the target component also as described in "Analog connections" (see pages 11, 13).
- To use the digital source components as the sub-room source, connect them using analog connection methods as well.

Digital output terminal

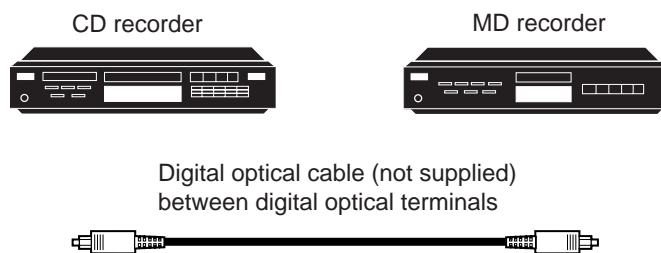

When the digital recording equipment such as an MD recorder and a CD recorder has a digital optical input terminal, connecting it to the DIGITAL OUT terminal enables you to perform digital-to-digital recording.

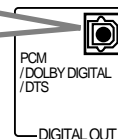

Note:

The digital signal format of the signals output through the DIGITAL OUT terminal is the same as that of the input signal. This means that when the DTS Surround signals are input, the DTS Surround signals are output.

Setting Up the RF Rod Antenna

The remote control supplied for this receiver can transmit both RF (Radio Frequency) signal as well as IR (infrared) signal. The RF rod antenna can receive the RF signals emitted from the remote control. So, with the RF rod antenna connected, you can operate the receiver at a distance of up to 15 m (50 feet) using RF signals sent from this receiver (more than twice as far as when using IR signals). Moreover, RF signals can go through walls and other objects in the house so you need not aim at the receiver directly. However, if the antenna cannot receive signals stably, you cannot operate the receiver correctly.

- The signal-reachable distance may differ depending on the operating conditions and circumstances. To improve transmitting conditions, change the distance to the receiver and the direction to transmit while operating the remote control.
- Without the RF rod antenna connected, you can operate the receiver with the remote control, aiming the remote control directly at the remote sensor on the receiver.

To set up the RF rod antenna

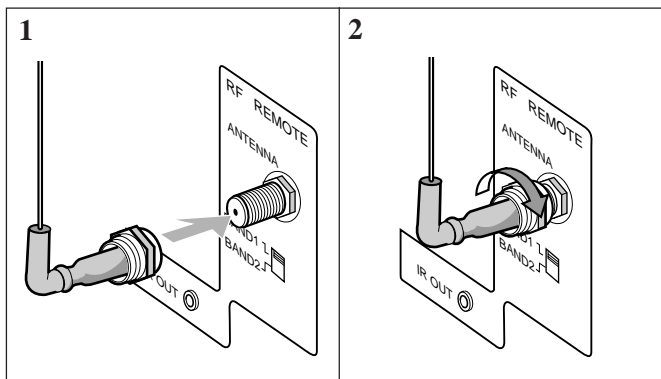

1. Insert the RF rod antenna to the RF REMOTE ANTENNA terminal.
2. Rotate the fixing nut to attach the RF rod antenna firmly.

Notes:

- To avoid a failure in the reception from the remote control, keep the connecting cables and the IR signal transmitter's cable away from the RF rod antenna.
- If your neighbour uses the same or similar RF remote control system, the receiver may happen to receive the RF signals sent from such an RF remote control system, which could cause your receiver to be operated unintentionally. If this happens, set the BAND selectors (both on the rear and on the remote control) to another band (either BAND 1 or BAND 2).

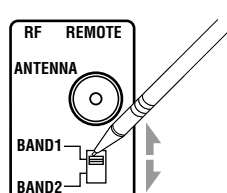

On the main unit's rear

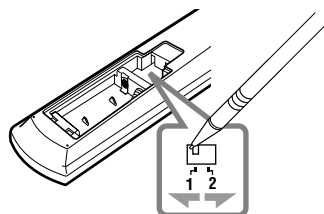

On remote control
(Inside the battery compartment)

If the problem still persists, stop using the RF rod antenna and the remote control, and consult your JVC dealer or the nearest JVC Service Center.

The RF rod antenna and IR signal Transmitter

The combination of the RF rod antenna and the IR signal transmitter (below) allows you to use the Multi-room function more conveniently.

The remote control supplied for this receiver can transmit both RF signal and IR signal at the same time. This receiver catches the RF signals emitted from the remote control, and converts them into IR signals, then transmits the converted signals to the remote sensor on the other components through IR signal transmitter.

This means that you can control not only this receiver but also the other components from the sub-room.

Setting Up the IR Signal Transmitter

The IR signal transmitter can transmit the IR signals.

It allows you to use the AV COMPU LINK system, and to operate other manufacturers' components without aiming the remote control directly at the remote sensor on the target components. In addition, the IR signal transmitter reduces the possibility of malfunction.

- The IR signal transmitter may not operate the target components depending on the operating conditions and circumstances—including the aiming angle and direction of the IR signal transmitter at the remote sensors of the target components. If this occurs, changing its aiming angle and direction at the remote sensors may solve the problem.

To set up the IR signal transmitter

1. Find the place where you attach the IR signal transmitter.
 - Place it where the signal can reach the remote sensor of the target components directly (in the line-of-sight).
 - If the cord length of the IR signal transmitter is not long enough, use an extension cord (not supplied).
2. Attach the double-sided adhesive tape (supplied) to the IR signal transmitter.

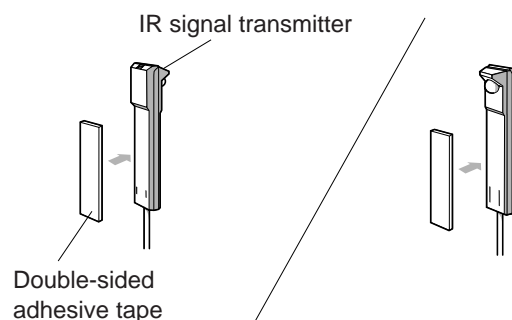

3. Connect the plug of the transmitter to the IR OUT jack of the receiver and attach the transmitter.

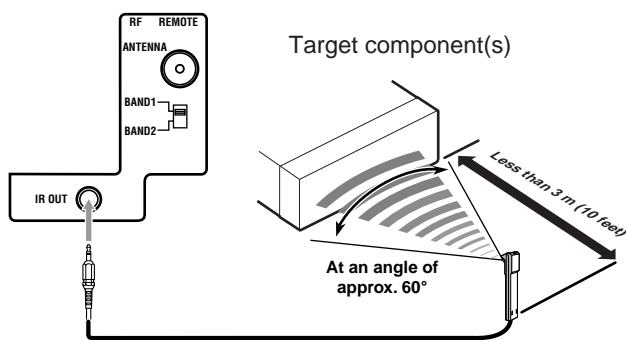

Signal-emitting angle of the transmitter

Horizontally: 60°

Vertically: 60°

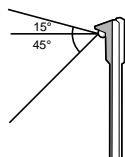
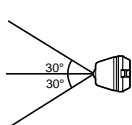

Connecting the Power Cord

Before plugging the receiver into an AC outlet, make sure that all connections have been made.

Plug the power cord into an AC outlet.

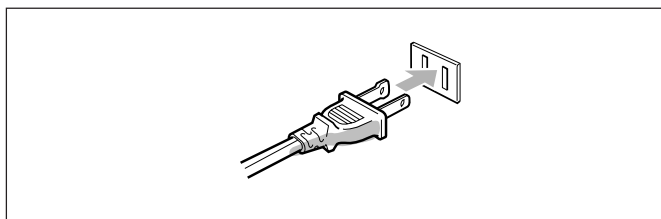

Keep the power cord away from the connecting cables and the antenna. The power cord may cause noise or screen interference. We recommend that you use a coaxial cable to connect the antenna, since it is well-shielded against interference.

Note:

The preset settings such as preset channels and sound adjustment may be erased in a few days in the following cases:

- When you unplug the power cord.
- When a power failure occurs.

CAUTIONS:

- Do not touch the power cord with wet hands.
- Do not pull on the power cord to unplug the cord. When unplugging the cord, always grasp the plug so as not to damage the cord.

Putting Batteries in the Remote Control

Before using the remote control, insert the two supplied batteries first.

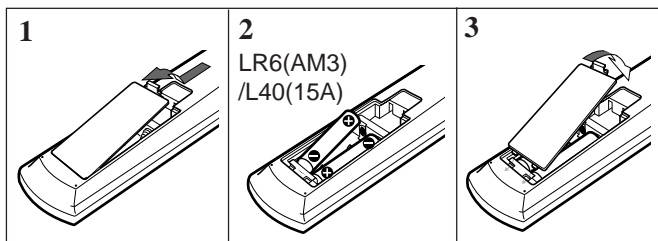

1. On the back of the remote control, remove the battery cover.

2. Insert the batteries.

- Make sure to match the polarity: (+) to (+) and (-) to (-).

3. Replace the cover.

If the remote control cannot transmit signals or operate the receiver correctly, replace the batteries. Use two LR6(AM3)/L40(15A) type dry-cell batteries.

- When the remote control transmits a signal, the signal transmission indicator on the remote's display lights up.

Notes:

- If you aim the remote control directly at the remote sensor on the receiver, you can operate the receiver at a distance of up to 7 m (23 feet).
- When replacing the batteries, finish it without delay; otherwise, the stored signals are all erased (see pages 67 and 71).

When using the remote control in the dark

Press LIGHT.

The buttons on the remote control are backlit while you are using the remote control.

If you do not press any button for about 5 seconds, the backlight will turn off.

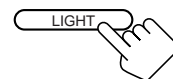

CAUTIONS:

Follow these precautions to avoid leaking or cracking cells:

- Place batteries in the remote control so they match the polarity: (+) to (+) and (-) to (-).
- Use the correct type of batteries. Batteries that look similar may differ in voltage.
- Always replace both batteries at the same time.
- Do not expose batteries to heat or flame.

Multi-Room Operations

Before operating this receiver any further, be familiar with this Multi-room function.

This function enables you to listen to different sources in two different places (we call these two places "main room" and "sub-room") by using this receiver.

This section explains only the required speaker connections, the concept, and basic operations of the Multi-room function. For more detailed operations, see the respective pages in this manual.

Required Connections for Sub-Room

1. Connect a TV to the SUB ROOM MONITOR OUT jack (either composite video or S-video jack).
2. Connect front speakers by using one of the methods described below (either Connection A or Connection B).

Sub-room Layout

Connection A
Connect the input jacks of another amplifier to the SUB ROOM PREOUT jacks on the rear panel, using a cable with RCA pin plugs (not supplied).

Connection B
See also page 8.

To use the sub-room TV.
Turn on and select the correct input for this receiver.

CAUTION : SPEAKER IMPEDANCE

LOW	HIGH
4 ~ 6 Ω	8 ~ 16 Ω

SPEAKER LOAD SELECTOR

Merits:

- This connection DOES allow you to always use the Surround/DSP mode using the center, surround, and surround back speakers (see pages 46 and 50) and the DVD MULTI playback mode (see page 53) for the main room sources.
- The output level through the SUB ROOM PREOUT jacks can either be fixed or be variable by setting it on the Setup Menu. (See "Preparing for the Sub-Room Operations—SUB ROOM" on page 40 for more details.)

Demerits:

- This connection DOES require another amplifier.

To use the sub-room front speakers.
Turn on and operate the other amplifier connected to the SUB ROOM PREOUT jacks correctly.

Note:
Usage of long audio cables/long speaker signal cables will deteriorate the signals and degrade the sound quality.

Merits:

- This connection DOES NOT require a power amplifier.

Demerits:

- When the sub-room speakers are activated, this connection DOES NOT allow you to use the Surround/DSP modes using the center, surround, and surround back speakers (see pages 46 and 50) and the DVD MULTI playback mode (see page 53) for the main room sources.
- When the Surround/DSP modes using the center, surround, and surround back speakers or when the DVD MULTI playback mode is activated for the main room sources, this connection DOES NOT allow you to use the sub-room speakers.

To use the sub-room front speakers connected to the FRONT 2/SUB ROOM SPEAKERS terminals
See "Preparing for the Sub-Room Operations—SUB ROOM" on page 40, and "Activating the Sub-Room Front Speakers" on page 30.

Note:
Usage of long speaker signal cables will deteriorate the signals and degrade the sound quality.

Basic Operating Procedure for Main Room

On the unit:

1. Press **STANDBY/ON** (STANDBY/ON).

The STANDBY lamp goes off, and the MAIN ROOM ON/OFF lamp lights up.

The front door moves down so that the source selecting buttons appear, and the buttons and controls on the unit work for the main room operations.

- For more details, see “Turning the Power On and Off (Standby)” on page 20.

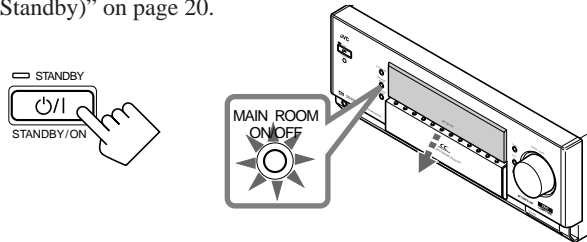

The last main room source is activated.



The last Surround/DSP mode or other information appears.

The volume level appears.

2. Select and play a source.

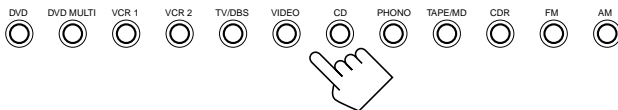

The sound comes out of the main room speakers.

3. Press **DOOR DOWN** so that you can use the other buttons inside the front door.



To close the front door, press **DOOR UP** once or twice. The front door moves up in two steps.

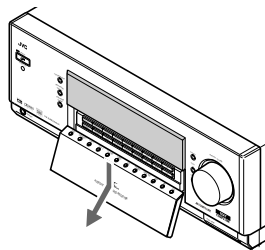

4. If no sound comes out of the front speakers, press **SPEAKERS 1** and/or **SPEAKERS 2/SUB ROOM** which you want to use.

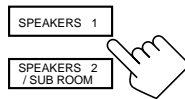

The selected front speaker indicator(s) light(s) up on the display.

- For more details, see “Activating the Main Room Front Speakers” on page 23.

5. Turn **MASTER VOLUME** to adjust the volume level of the sound through the main room speakers.

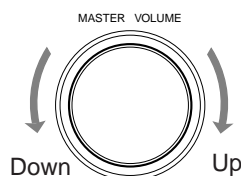

From the remote control:

1. Set **MAIN ROOM/SUB ROOM (LEARN/TRANSMIT)** selector to “**MAIN ROOM.**”

Now the buttons and controls on the remote control work for the main room operations.

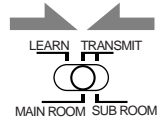

2. Press **AUDIO 1 (ON)**.

The STANDBY lamp goes off, and the MAIN ROOM ON/OFF lamp on the unit lights up.

The front door moves down.

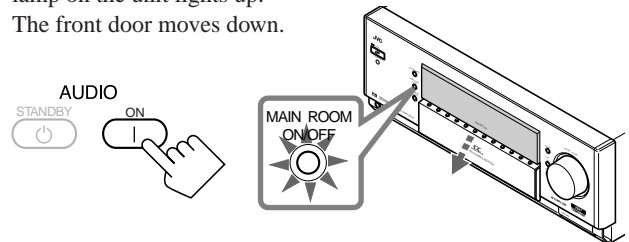

The last main room source is activated.



The last Surround/DSP mode or other information appears.

The volume level appears.

3. Select and play a source.

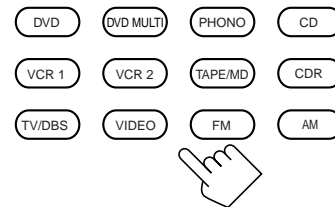

The sound comes out of the main room front speakers.

- See also “Turning the Power On and Off (Standby)” on page 20.
- If no sound comes out of the front speakers, press **SPEAKERS 1** and/or **SPEAKERS 2/SUB ROOM** on the unit (inside the front door). The selected front speaker indicator(s) light(s) up on the display. For more details, see “Activating the Main Room Front Speakers” on page 23.

4. Press **VOLUME +/-** to adjust the volume level of the sound through the main room speakers.

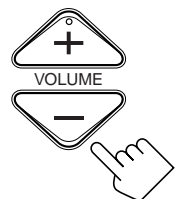

Basic Operating Procedure for Sub-Room

The sources and functions available for the sub-room operations are limited.

For more details on the sub-room operations, see “Sub-Room Operations” on pages 27 to 30.

On the unit:

1. Press **STANDBY/ON** (STANDBY/ON).

The STANDBY lamp goes off, and the MAIN ROOM ON/OFF lamp lights up.

The front door moves down so that the source selecting buttons appear, and the buttons and controls on the unit work for the main room operations.

- For more details, see “Turning the Power On and Off (Standby) and Selecting the Sub-Room Operations” on page 27.

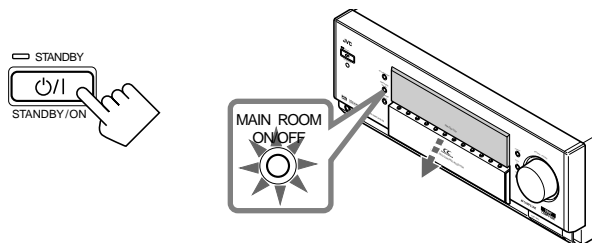

2. Press **SUB ROOM ON/OFF** so that the **SUB ROOM ON/OFF** lamp lights up.

The sound comes out of the sub-room front speakers.

- If no sound comes out of the front speakers, see page 17.



3. Press **DOOR DOWN** so that you can use the other buttons inside the front door.



To close the front door, press **DOOR UP** once or twice. The front door moves up in two steps.

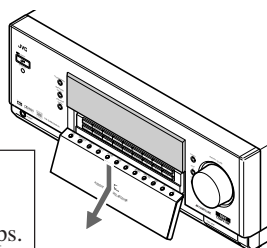

4. Press **SUB ROOM CONTROL** so that “SUB ROOM” and the previously selected sub-room source name appear on the display.

Now the buttons and controls on the unit work for the sub-room operations.

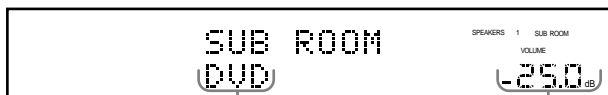

The last sub-room source appears. The sub-room volume level appears.

5. Select and play a source.

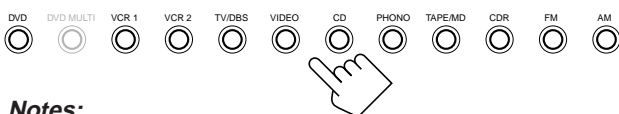

Notes:

- You cannot select DVD MULTI as a source for the sub-room.
- When “TV” has been assigned as the source name to the TV/DBS button, it does not work. To change the source name, see “Changing the Source Name” on page 25.

6. Turn **MASTER VOLUME** to adjust the volume level of the sound through the sub-room front speakers.

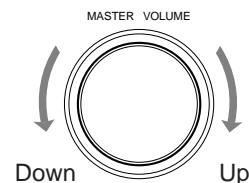

Note:

When connecting the sub-room front speakers to the SUB ROOM PREOUT jacks, the MASTER VOLUME control will not be able to adjust the volume (see “Preparing for the Sub-Room Operations—SUB ROOM” on page 40).

From the remote control:

When operating the receiver using the remote control, the display on the unit always shows the main room source information though you are operating it for the sub-room source.

1. Set **MAIN ROOM/SUB ROOM (LEARN/TRANSMIT)** selector to “SUB ROOM.”

Now the buttons and controls on the remote control work for the sub-room operations.

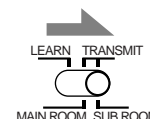

2. Press **AUDIO 1 (ON)**.

The STANDBY lamp on the unit goes off, and the SUB ROOM ON/OFF lamp on the unit lights up.

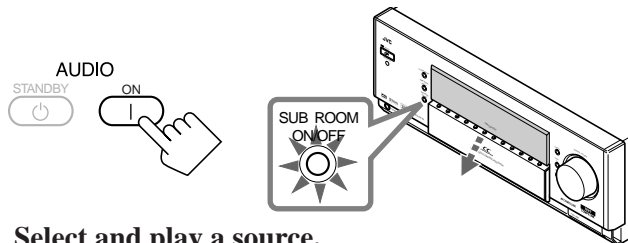

3. Select and play a source.



The sound comes out of the sub-room front speakers.

- If no sound comes out of the front speakers, see page 17.

Notes:

- You cannot select DVD MULTI as a source for the sub-room.
- When “TV” has been assigned as the source name to the TV/DBS button, it does not work. To change the source name, see “Changing the Source Name” on page 25.

4. Press **VOLUME +/-** to adjust the volume level of the sound through the sub-room front speakers.



Note:

When connecting the sub-room front speakers to the SUB ROOM PREOUT jacks, the VOLUME +/- buttons will not be able to adjust the volume (see “Preparing for the Sub-Room Operations—SUB ROOM” on page 40).

Main Room Operations

This section explains only the operations commonly used when you play any sound source in the main room. See pages 27 to 30 for the sub-room operations.

- Before performing main room operations, it is recommended to finish the basic settings on pages 33 to 40.

IMPORTANT:

Check to see if the following before or while using the buttons and controls.

For the main room operations:

The MAIN ROOM ON/OFF lamp on the unit is lit.

• When using the unit:

- “SUB ROOM” is not shown in the main display.
- Press DOOR DOWN to use the buttons inside the front door.
- To close the front door, press DOOR UP.



• When using the remote control:

- Set the MAIN ROOM/SUB ROOM (LEARN/TRANSMIT) selector to “MAIN ROOM.”
- Check the indication shown on the remote’s display when you press a button—this indicates the remote control operation mode together with multi-room operation mode (either MAIN ROOM or SUB ROOM) for a while (10 or 5 seconds).

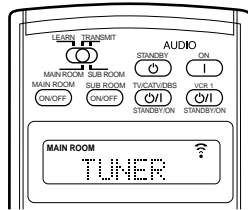
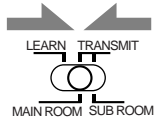

Ex. When you press FM with MAIN ROOM/SUB ROOM (LEARN/TRANSMIT) selector set to “MAIN ROOM.”

To turn off the power (into standby mode), press **STANDBY/ON** (STANDBY/ON) again.

The STANDBY lamp lights up, and the front door automatically closes. (The MAIN ROOM ON/OFF and/or SUB ROOM ON/OFF lamp goes off.)

- A small amount of power is consumed in standby mode. To turn the power off completely, unplug the AC power cord.

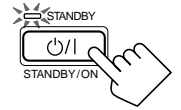

From the remote control:

To turn on the power, press **AUDIO | (ON)**.

The STANDBY lamp goes off, and the MAIN ROOM ON/OFF lamp on the unit lights up.

The front door moves down (so that the source selecting buttons appear).

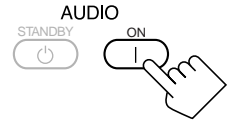

The last main room source is activated.



The last Surround/DSP mode or other information appears.

The volume level appears.

The currently selected speakers 1 and/or 2 indicator(s) also light(s) up on the display.

- If neither speakers 1 nor 2 indicator is lit on the display, see “Activating the Main Room Front Speakers” on page 23.

Turning the Power On and Off (Standby)

On the unit:

To turn on the power, press **STANDBY/ON** (STANDBY/ON).

The STANDBY lamp goes off, and the MAIN ROOM ON/OFF lamp lights up. The front door moves down (so that the source selecting buttons appear).

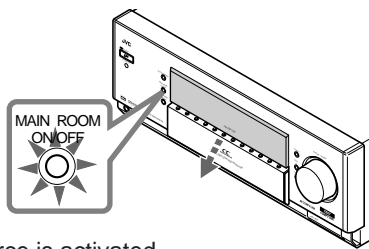
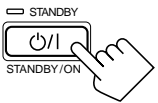

The last main room source is activated.



The last Surround/DSP mode or other information appears.

The volume level appears.

The currently selected speakers 1 and/or 2 indicator(s) also light(s) up on the display.

- If neither speakers 1 nor 2 indicator is lit on the display, see “Activating the Main Room Front Speakers” on page 23.

To turn off the power (into standby mode), press **AUDIO | (STANDBY)**.

The STANDBY lamp lights up, and the front door automatically closes. (The MAIN ROOM ON/OFF and/or SUB ROOM ON/OFF on the unit lamp goes off.)



Notes:

- Before you turn off the receiver in the main room, make sure if no one is listening to any source in the sub-room (the SUB ROOM ON/OFF lamp is lit on the display) since the sub-room sound will also be turned off unexpectedly.
- If you have turned off the receiver with the volume level set at more than level “-35 dB,” the volume level will be automatically set at level “-35 dB” next time you turn on the receiver.

When you turn on the TV connected to the TV SOUND/DBS jacks on the rear

This receiver automatically turns on and selects “TV” as the main room source about 5 seconds after you turn on the TV. (If you change the source name from “TV” to “DBS,” the receiver will not turn on along with the TV. See “Changing the Source Name” on page 25.)

Canceling the Main Room Operations

To stop the main room operations and sounds from the main room speakers, press MAIN ROOM ON/OFF so that the MAIN ROOM ON/OFF lamp goes off.



On the unit



From the remote control

The currently selected front speakers indicator(s) also go(es) off from the display (no sound will be heard in the main room).

To use this receiver for the main room operations again, press MAIN ROOM ON/OFF again (the MAIN ROOM ON/OFF lights up).

The front speakers indicator(s) previously selected light(s) up. Now the buttons and controls on the unit work for the main room operations.

Notes:

- If you have turned off the receiver with the volume level set at more than level “-35 dB,” the volume level will be automatically set at level “-35 dB” next time you turn on the receiver.
- If “TURN ON MAIN OR SUB ROOM” appears on the display, press MAIN ROOM ON/OFF or SUB ROOM ON/OFF to listen to the sound in the main room or in the sub-room; otherwise, the receiver will turn off after about 1 minute.

Selecting the Main Room Source to Play

Press one of the source selecting buttons.

- The selected source name and Surround/DSP mode also appear on the display.

On the unit:

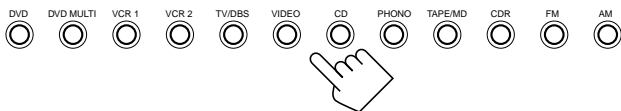

From the remote control:

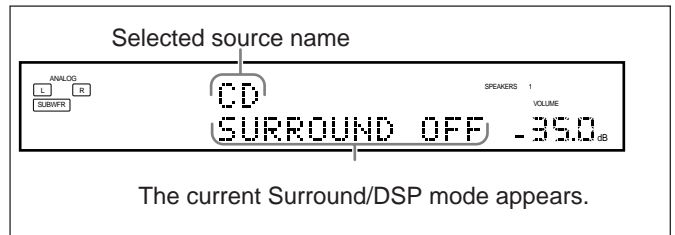
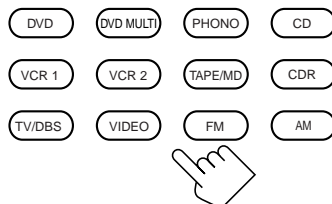

- DVD : Selects the DVD player.
- DVD MULTI : Selects the DVD player for viewing the digital video disc using the analog discrete output mode (5.1CH reproduction). To enjoy the DVD MULTI playback, see page 53.
- VCR 1 : Selects the video component connected to the VCR 1 jacks.
- VCR 2 : Selects the video component connected to the VCR 2 jacks.
- TV/DBS : Selects TV sounds (or the DBS tuner).
- VIDEO : Selects the video component connected to the VIDEO jacks.
- CD* : Selects the CD player.
- PHONO* : Selects the turntable.
- TAPE/MD* : Selects the cassette deck (or the MD recorder).
- CDR* : Selects the CD recorder.
- FM* : Selects an FM broadcast.
- AM* : Selects an AM broadcast.

Notes:

- When connecting an MD recorder (to the TAPE/MD jacks), and a DBS tuner (to the TV SOUND/DBS jacks), change the source names shown on the display. For details, see “Changing the Source Name” on page 25.
- When you press one of the audio source selecting buttons on the remote control marked with an asterisk (*), the receiver automatically turns on. If you turn on the receiver with the MAIN ROOM/SUB ROOM (LEARN/TRANSMIT) selector set to “SUB ROOM,” press MAIN ROOM ON/OFF to activate the main room operations.
 - Pressing one of the audio source selecting buttons on the remote control (except FM and AM) with the MAIN ROOM/SUB ROOM (LEARN/TRANSMIT) selector set to “MAIN ROOM” while the receiver is turned on but the main room is turned off, the main room is turned on with the audio source selected.

Speaker and signal indicators on the display

By checking the following indicators, you can easily confirm which speakers you are activating and which signals are coming into this receiver from the source.

Speaker indicators	Signal indicators
L C R	L C R
SUBWFR	LFE
LS RS	LS S RS
SB SB	SB SB

The speaker indicators light only —:

- The frames of “L,” “C,” “R,” “LS,” “RS,” and “SB” light up, when the corresponding speakers are set to “LARGE” or “SMALL” (see “Setting the Speakers—SPEAKER SETTING” on page 36) AND when the corresponding speaker is required for the DSP mode currently selected.
- When “SUBWOOFER” is set to “YES,” [SUBWFR] lights up. (See “Setting the Speakers—SPEAKER SETTING” on page 36.)

The signal indicators light up to indicate the incoming signals.

- L : • **When digital input is selected:** Lights up when the left channel signal comes in.
- **When analog input is selected:** Always lights up.
- R : • **When digital input is selected:** Lights up when the right channel signal comes in.
- **When analog input is selected:** Always lights up.
- C : Lights up when the center channel signal comes in.
- LFE : Lights up when the LFE channel signal comes in.
- LS : Lights up when the left surround channel signal comes in.
- RS : Lights up when the right surround channel signal comes in.
- S : Lights up when the monaural surround channel signal comes in.
- SB : Lights up when the surround back channel signal comes in.

Note:

When "DVD MULTI" is selected as the source, "L," "C," "R," "LFE," "LS" and "RS" light up.

To obtain the best performance of this receiver while using the Surround/DSP modes, check the speaker and signal indicators on the display carefully and set the speakers correctly.

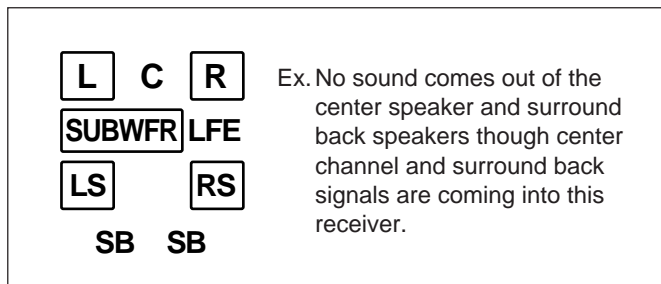

Selecting different sources for picture and sound

While watching pictures from a video source, you can listen to sound of a different source.

On the unit:

You can select any component as the sound source.

1. Press **SOUND SELECTOR** (inside the front door) while viewing the picture from a video component such as the VCR or DVD player, etc.



"AUDIO" appears followed by the current sound source.

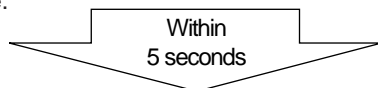

2. Press one of the source selecting buttons.

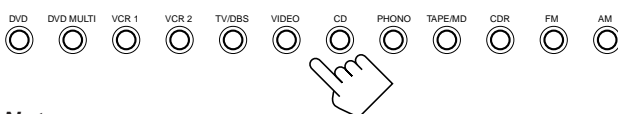

Note:

When "TV" has been assigned as the source name to the TV/DBS button, it does not work. To change the source name, see "Changing the Source Name" on page 25.

To match the video source and sound source again, repeat steps 1 and 2, and select the same sound source as the video source in step 2.

From the remote control:

You can select only audio component as the sound source when using the remote control.

- Once you have selected a video source, pictures of the selected source are sent to the TV until you select another video source.

Press one of the audio source selecting buttons—**PHONO, CD, TAPE/MD, CDR, FM, AM**—while viewing the picture from a video component such as the VCR or DVD player, etc.

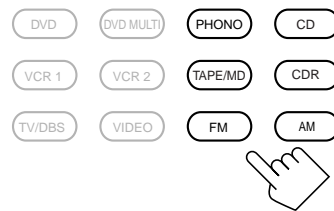

Adjusting the Main Room Volume

On the unit:

To increase the volume, turn MASTER VOLUME clockwise.

To decrease the volume, turn it counterclockwise.

- When you turn MASTER VOLUME rapidly, the volume level also changes rapidly.
- When you turn MASTER VOLUME slowly, the volume level also changes slowly.

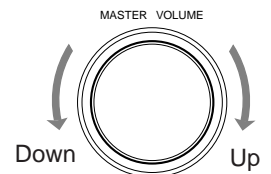

From the remote control:

To increase the volume, press VOLUME +.

To decrease the volume, press VOLUME -.



CAUTIONS:

- Always set the volume to the minimum before starting any source. If the volume is set at a high level, the sudden blast of sound energy can permanently damage your hearing and/or ruin your speakers.
- Be careful not to turn up the volume so high when controlling the receiver without listening to the playback sound. For example, when adjusting the volume level in the sub-room from the main room.

Notes:

- The volume level can be adjusted within the range of "- - dB" (minimum) to "+18.0 dB" (maximum).
- If you set One Touch Operation to "ON" (see page 40), you do not have to adjust the volume level each time you change the source. It is automatically set to the stored level. (However, if you have turned off the receiver with the volume level set at more than level "-35 dB," the volume level will be automatically set at level "-35 dB" next time you turn on the receiver.)

Activating the Main Room Front Speakers

When shipped from the factory, both pairs of the front speakers have been set to be used in the main room.

- To use the front speakers connected to the FRONT 2/SUB ROOM SPEAKERS terminals in the sub-room, see “Preparing for the Sub-Room Operations—SUB ROOM” on page 40, and “Activating the Sub-Room Front Speakers” on page 30.

IMPORTANT:

You can activate two pairs of the front speakers at the same time only when the SPEAKER LOAD SELECTOR switch on the rear panel is set to the “HIGH” position and when signals are sent only to the front speakers. Otherwise, activating one pair of the speakers deactivates the other.

On the unit ONLY:

When you have connected two pairs of the front speakers and place them in the main room, you can select which to use.

To use the speakers connected to the FRONT 1 SPEAKERS terminals, press SPEAKERS 1 (inside the front door) so that the speakers 1 indicator lights up on the display. (Make sure that the front speakers 2 indicator is not lit on the display.)

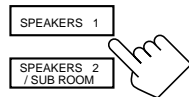

To use the speakers connected to the FRONT 2/SUB ROOM SPEAKERS terminals, press SPEAKERS 2/SUB ROOM (inside the front door) so that the front speakers 2 indicator lights up on the display. (Make sure that the front speakers 1 indicator is not lit on the display.)

To use both sets of the speakers, press SPEAKERS 1 and SPEAKERS 2/SUB ROOM so that the front speakers 1 and 2 indicators light up on the display.

To use neither sets of the speakers, press SPEAKERS 1 and SPEAKERS 2/SUB ROOM so that the front speakers 1 and 2 indicators disappear from the display. (“HEADPHONE” appears on the unit’s display.)

Note:

In the following cases, the speakers connected to the FRONT 2/SUB ROOM SPEAKERS terminals are deactivated even if both pairs of the front speakers are activated.

- If you select “DVD MULTI” as the source.
- If you select any of the Surround/DSP modes which activates the center and/or surround speaker(s).

Listening only with headphones:

Sounds through the front speakers and the subwoofer shut off when connecting a pair of headphones to the PHONES jack. (“HEADPHONE” appears on the unit’s display.)

You can enjoy the following sounds through the headphones:

- If the Surround mode is activated, you can enjoy surround effect. (For details, see “3D HEADPHONE Mode” on page 47.)
- If a DSP mode is activated, you can enjoy the DSP effect. (For details, see “HEADPHONE Mode” on page 51.)

CAUTION:

Be sure to turn down the volume before connecting or putting on headphones, as high volume can damage both the headphones and your hearing.

Selecting the Analog or Digital Input Mode

When you have connected digital source components using the digital terminals (see page 14), you need to select the digital input mode.

Before you start, remember...

- The digital input (DIGITAL IN) terminal setting should be correctly done for the sources you want to select the digital input mode for (see “Setting the Digital Input Terminals—DIGITAL IN” on page 38). Without setting this digital input terminal correctly, you cannot change the input mode from analog input to digital input even if you follow the procedure below.
- The digital input can be used for the main room sources. The analog input is always selected as the sub-room source without respect to this setting.

- Press one of the source selecting buttons (DVD, VCR1, TV/DBS, CD, CDR, or TAPE/MD)* for which you want to change the input mode.



On the unit



On the remote control

Note:

- * You can select the digital input only for the sources which you have selected the digital input terminals for. (See “Setting the Digital Input Terminals—DIGITAL IN” on page 38.) In addition, when “TAPE” has been assigned as the source name to the TAPE/MD button, it does not work in this step. To change the source name, see “Changing the Source Name” on page 25.

- Press INPUT MODE/INPUT ATT (or ANALOG/DIGITAL DIGITAL INPUT) to change the input mode.

- Each time you press the button, the input mode changes as follows:

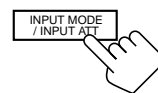

On the unit
(inside the front door)

ANALOG/DIGITAL

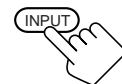

On the remote control



DIGITAL AUTO : Select this for the digital input mode. The receiver automatically detects the incoming signals. The DIGITAL AUTO indicator lights up on the display, and the digital signal format indicators for the detected signals also light up.

ANALOG : Select this for the analog input mode. The ANALOG indicator lights up.

When selecting “DIGITAL AUTO,” the following indicators indicate the digital signal format of the incoming signal.

- LINEAR PCM** : Lights up when Linear PCM signals come in.
- DOLBY DIGITAL** : Lights up when Dolby Digital or Dolby Digital EX signals come in.
- dts** : Lights up when DTS Surround or DTS-ES signals come in.

No indicator lights up when the receiver cannot recognize the digital signal format of the incoming signals.

When playing a software encoded with the Dolby Digital or DTS Surround, the following symptoms may occur:

- Sound does not come out at the beginning of playback.
- Noise comes out while searching for or skipping chapters or tracks.

In this case, press RIGHT (or LEFT) on the unit to select “DOLBY DIGITAL” or “DTS” while “DIGITAL AUTO” still remains on the display.

- Each time you press the button, the input mode changes as follows:

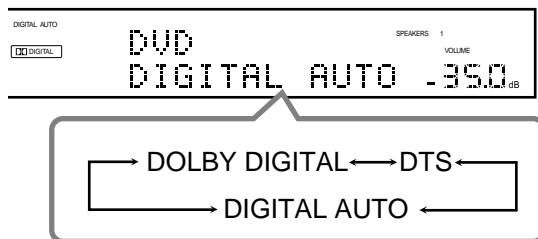

When “DOLBY DIGITAL” or “DTS” is selected, the DIGITAL AUTO indicator goes off, and the corresponding digital signal format indicator (**DOLBY DIGITAL** or **dts**) lights up on the display.

- If the incoming signal does not match the selected digital signal format, the frame of the selected indicator will flash.

Note:

When you turn off the power or select another source, “DOLBY DIGITAL” and “DTS” settings are canceled and the digital input mode is automatically reset to “DIGITAL AUTO.”

Attenuating the Input Signal

When the input level of the playing source is too high, the sounds will be distorted. If this happens, you need to attenuate the input signal level to prevent sound distortion.

- You have to make this setting for each source.

On the unit ONLY:

Press and hold **INPUT MODE/INPUT ATT** (inside the front door) so that the **INPUT ATT** indicator lights up on the display.

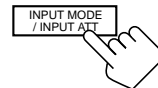

- Each time you press and hold the button, the input attenuator mode turns on (“INPUT ATT ON”) or off (“INPUT ATT OFF”).

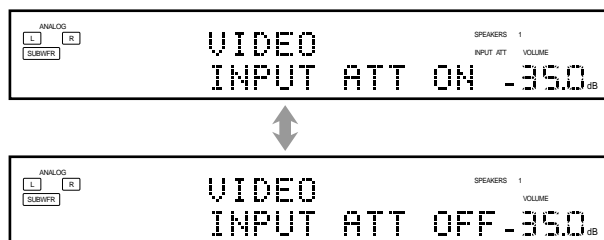

Ex. When the source is “VIDEO.”

Notes:

- This effect is applied to only the main room sources connected to the analog terminals.
- This function is not valid for the DVD MULTI playback mode.

Muting the Main Room Sound

From the remote control ONLY:

Press **MUTING** to mute the sound through all speakers in the main room and headphones connected.



“MUTING” appears on the display and the volume turns off (the volume level indicator goes off).



Ex. When the source is “VIDEO.” The volume level indicator goes off.

To restore the sound, press **MUTING** again so that “MUTING OFF” appears on the display for a while.

- Turning **MASTER VOLUME** on the unit or pressing **VOLUME +/-** on the remote control also restores the sound.



Changing the Display Brightness

You can dim the display.

Press DIMMER.

- Each time you press the button, the brightness level of the display changes as follows:

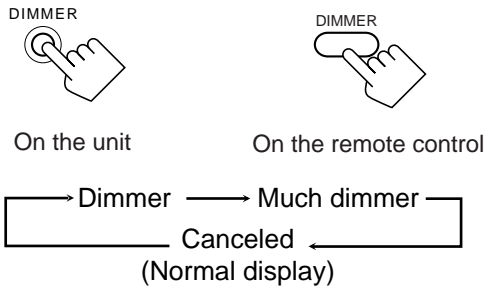

Note:

Even though the dimmer is in use, the display brightens for a while when you operate the receiver (except when changing the source).

Turning Line Direct On and Off

You can enjoy the sound closer to original source by skipping the sound adjustments such as Midnight mode (see page 38), speaker output level adjustments (see page 44) and Parametric Equalizer (see page 44). You can only adjust the volume level while Line Direct is in use.

- You have to make this setting for each source.

Press LINE DIRECT.

- Each time you press the button, Line Direct turns on and off.
 - When Line Direct turns on, "LINE DIRECT" appears in the main display.

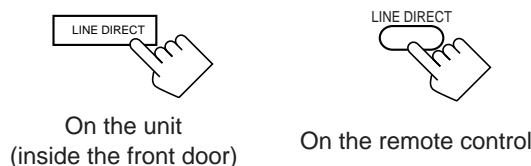

Ex. When the source is "VIDEO."

Notes:

- This function is applied only to the main room sources.
- If you turn on Line Direct while using the Surround and DSP modes, the effect changes as follows:

Input \ Mode	Surround	DSP
Analog	Not valid	Not valid
Digital	Valid	Not valid

- If you turn on Line Direct, CC Converter (see the right column) is canceled.
- Turning off Line Direct activates the sound adjustments previously selected such as Midnight mode, speaker output level adjustments and Parametric Equalizer.
- If you turn off Line Direct while listening to an analog source, muting time* will be a little longer. (* The period during which no sound comes out.)

Making Sounds Natural

JVC's CC (Compensative Compression) Converter eliminates jitter and ripples, achieving a drastic reduction in digital distortion by processing the digital music data in 24 bit-quantization and by expanding the sampling frequency to 176.4 kHz (for fs 44.1 kHz signals)/192 kHz (for fs 48 kHz signals).

By using the CC Converter, you can obtain a natural sound field from any source.

Press CC CONVERTER so that the CC CONVERTER lamp lights up.

- Each time you press the button, CC Converter turns on and off (the lamp goes off) alternately.



Note:

- This function is applied only to the main room sources.
- You cannot use this function while Line Direct or THX Surround is in use. If you turn on Line Direct or THX Surround while this function is in use, this function will be canceled.

Changing the Source Name

When you have connected an MD recorder to the TAPE/MD jacks or the DBS tuner to the TV SOUND/DBS jacks on the rear panel, change the source name which will be shown on the display when you select the MD recorder or DBS tuner as the source.

On the unit ONLY:

When changing the source name from "TAPE" to "MD":

- Press TAPE/MD.
- Press and hold TAPE/MD until "ASSGN. MD" appears on the display.



When changing the source name from "TV" to "DBS":

- Press TV/DBS.
- Press and hold TV/DBS until "ASSGN. DBS" appears on the display.

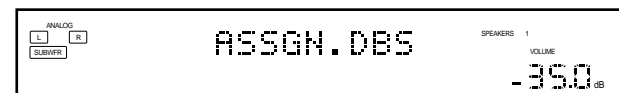

To change the source name to "TAPE" or "TV," repeat the same procedure above — press and hold TAPE/MD to select "TAPE," or press and hold TV/DBS to select "TV" in step 2.

- While selecting "DBS" as the sub-room source, you cannot change the source name to "TV."

Notes:

- Once you change the source name, it is applied both for the main room source and sub-room source.
- Without changing the source name, you can still use the connected components. However, there may be some inconvenience.
 - “TAPE” or “TV” will appear on the display when you select the MD recorder or DBS tuner.
 - You cannot use the digital input (see page 23) for the MD recorder.
 - You cannot use the COMPU LINK remote control system (see page 54) to operate the MD recorder.

Using the Sleep Timer

Using the Sleep Timer, you can fall asleep to music and know the receiver will turn off by itself rather than play all night.

- The Sleep Timer works for the main room source only.

From the remote control ONLY:

Press SLEEP repeatedly.

The SLEEP indicator lights up on the display, and the shut-off time changes as follows (in minutes):

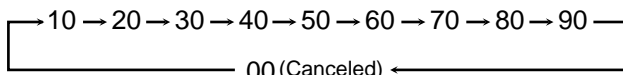

Ex. When the source is “VIDEO.”

When the shut-off time comes

The receiver turns off automatically.

- If the sub-room source is still played (the SUB ROOM ON/OFF lamp is lit) when the shut-off time comes, the receiver will not turn off, but only the main room source will shut off.

To check or change the time remaining until the shut-off time

Press SLEEP once.

The remaining time until the shut-off time appears in minutes.

- To change the shut-off time, press SLEEP repeatedly.

To cancel the Sleep Timer

Press SLEEP repeatedly until “SLEEP 00min.” appears on the display. (The SLEEP indicator goes off.)

- Turning off the power also cancels the Sleep Timer.

Recording a Source

For analog-to-analog recording

- You can record any analog source through the receiver to—
- the cassette deck (or MD recorder) connected to the TAPE/MD jacks,
 - the VCRs connected to the VCR 1 and VCR 2 jacks, and
 - the CD recorder connected to the CDR jacks
- at the same time.

For digital-to-digital recording

You can record the currently selected digital input source through the receiver to a digital recording device connected to the DIGITAL OUT terminal.

Notes:

- Analog-to-digital and digital-to-analog recordings are not possible.
- All sound adjustments cannot affect the recording.
- The test tone signal (see pages 44, 49) does not come out through the DIGITAL OUT terminal.

IMPORTANT:

- While recording, do not turn off the receiver or main room source; otherwise, recording will stop.
- If the same source is selected both for the main room and the sub-room, operating the sub-room source will affect the recording.

Basic adjustment auto memory

This receiver memorizes sound settings for each source—

- when you turn off the power,
- when you change the source,
- when you change the analog/digital input mode (see page 23), and
- when you turn on One Touch Operation (see page 40).

When you change the source, the memorized settings for the newly selected source are automatically recalled.

The following can be stored for each source:

- Analog/digital input mode (see page 23)
- Input attenuator mode (see page 24)
- Line Direct (see page 25)
- Midnight mode (see page 38)
- Speaker channel output levels (see page 44)
- Parametric Equalizer setting (see page 44)
- DSP Parameters (see page 45)
- THX Surround On/Off setting (see page 48)
- Surround mode On/Off setting (see page 48)
- DSP mode selection (see page 52)

Notes:

- If the source is FM or AM, you can assign a different setting for each band.
- If you want to memorize the volume level together with the above setting, set “ONE TOUCH OPERATION” to “ON” (see page 40).

Sub-Room Operations



This section explains only the operations used when you play a sound source in the sub-room. See pages 20 to 26 for the main room operations.

- Before performing sub-room operations, it is recommended to finish the basic settings on pages 33 to 40.

IMPORTANT:

Check to see if the following before or while using the buttons and controls.

For the sub-room operations:

The SUB ROOM ON/OFF lamp on the unit is lit.

• When using the unit:

- “SUB ROOM” is shown in the main display.
- Press DOOR DOWN to use the buttons inside the front door.
- To close the front door, press DOOR UP.



• When using the remote control:

When operating the receiver using the remote control, the display on the unit always shows the main room source information though you are operating it for the sub-room source.

- Set the MAIN ROOM/SUB ROOM (LEARN/TRANSMIT) selector to “SUB ROOM.”
- Check the indication shown on the remote’s display when you press a button—this indicates the remote control operation mode together with multi-room operation mode (either MAIN ROOM or SUB ROOM) for a while (10 or 5 seconds).

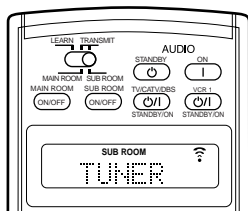
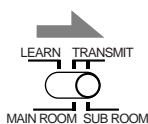

Ex. When you press FM with MAIN ROOM/SUB ROOM (LEARN/TRANSMIT) selector set to “SUB ROOM.”

To use the sub-room TV (connected to the SUB ROOM MONITOR OUT jack)

Turn on the TV and select the correct input for this receiver manually.

For those who connect the sub-room front speakers to the SUB ROOM PREOUT jacks using another amplifier (see page 17).

You have to determine how to adjust the volume level through the sub-room front speakers. (See “Preparing for the Sub-Room Operations—SUB ROOM” on page 40 for more details.)

To use the sub-room front speakers

- 1 Turn on the other amplifier connected to the SUB ROOM PREOUT jacks.
- 2 Adjust the volume level through sub-room front speakers either on the other amplifier or on this receiver (depending on the SUB PREOUT setting on the SUB ROOM submenu).

Turning the Power On and Off (Standby) and Selecting the Sub-Room Operations

On the unit:

1. Press **STANDBY/ON** (STANDBY/ON).

The STANDBY lamp goes off, and the MAIN ROOM ON/OFF lamp lights up.

The front door moves down so that the source selecting buttons appear.

- The unit is now activated only for the main room operations.

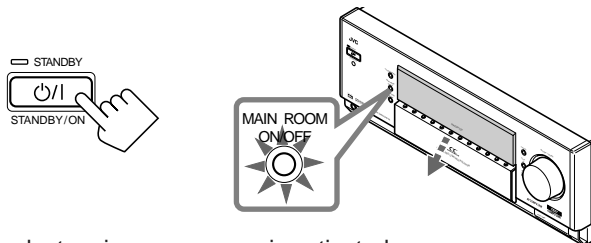

The last main room source is activated.



The last Surround/DSP mode or other information appears.

The volume level appears.

The currently selected speakers 1 and/or 2 indicator(s) light(s) up on the display.

2. Press **SUB ROOM ON/OFF** so that the **SUB ROOM ON/OFF** lamp lights up.



- When connecting the sub-room front speakers to the FRONT 2/SUB ROOM SPEAKERS terminals, see also “Preparing for the Sub-Room Operations—SUB ROOM” on page 40, and “Activating the Sub-Room Front Speakers” on page 30.

3. Press **SUB ROOM CONTROL** (inside the front door) so that “SUB ROOM” and the previously selected sub-room source name appear on the display.



The last sub-room source appears.

The sub-room volume level appears.

Now the buttons and controls on the unit work for the sub-room operations.

- Each time you press the button, the buttons and controls on the unit are activated or deactivated for the sub-room operations.

To turn off the power (into standby mode), press **STANDBY/ON** again.

The STANDBY lamp lights up, and the front door automatically closes. (The MAIN ROOM ON/OFF and/or SUB ROOM ON/OFF lamp goes off.)

- A small amount of power is consumed in standby mode. To turn the power off completely, unplug the AC power cord.

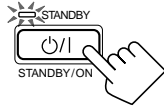

From the remote control:

1. Set MAIN ROOM/SUB ROOM (LEARN/TRANSMIT) selector to "SUB ROOM."

Now the buttons on the remote control work for the sub-room operations.

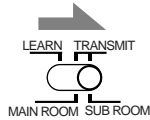

2. Press AUDIO | (ON).

The STANDBY lamp on the unit goes off, and the SUB ROOM ON/OFF lamp on the unit lights up.

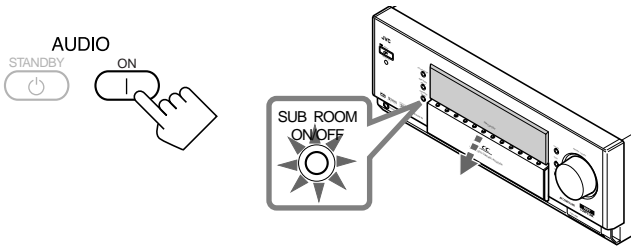

- When connecting the sub-room front speakers to the FRONT 2/SUB ROOM SPEAKERS terminal, see also "Preparing for the Sub-Room Operations—SUB ROOM" on page 40, and "Activating the Sub-Room Front Speakers" on page 30.

To turn off the power (into standby mode), press **AUDIO** (STANDBY).

The STANDBY lamp lights up, and the front door automatically closes. (The MAIN ROOM ON/OFF and/or SUB ROOM ON/OFF lamp on the unit goes off.)

Note:

If you have turned off the receiver with the volume level set at more than level "-35 dB," the volume level will be automatically set at level "-35 dB" next time you turn on the receiver.

Canceling the Sub-Room Operations

On the unit:

To stop the sub-room operations and sounds through the sub-room speakers, press **SUB ROOM ON/OFF** so that the SUB ROOM ON/OFF lamp goes off.



No sound will be heard in the sub-room, and the display changes to show the main room source.

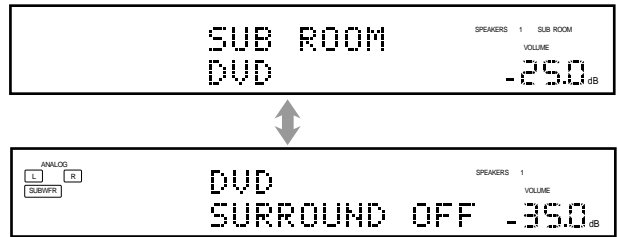

To use this receiver for the sub-room operations again

1. Press SUB ROOM ON/OFF again so that the SUB ROOM ON/OFF lamp lights up.



2. Press SUB ROOM CONTROL (inside the front door).

The name of the current source for the sub-room appears on the display.

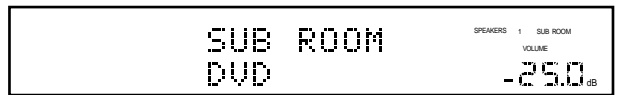

From the remote control:

To stop the sub-room operations and sounds through the sub-room speakers, press **SUB ROOM ON/OFF** so that the SUB ROOM ON/OFF lamp on the unit goes off.



To use this receiver for the sub-room operations again, press **SUB ROOM ON/OFF** again.



Notes:

- If you have turned off the sub-room sound with the volume level set at more than level "-35 dB," the volume level will be automatically set at level "-35 dB" next time you turn on the sub-room sound.
- If "TURN ON MAIN OR SUB ROOM" appears on the display, press **MAIN ROOM ON/OFF** or **SUB ROOM ON/OFF** to listen to the sound in the main room or in the sub-room; otherwise, the receiver will turn off after about 1 minute.

Selecting the Sub-Room Source to Play

Press one of the source selecting buttons.

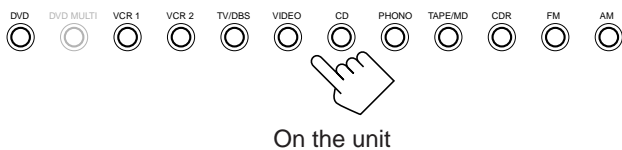

On the unit

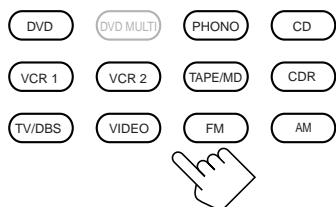
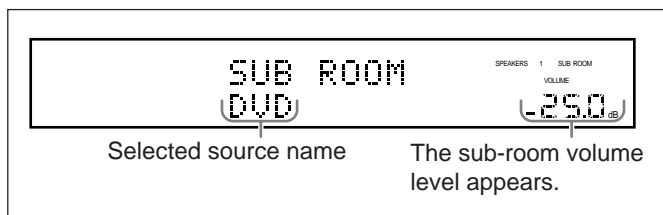

On the remote control

- DVD : Selects the DVD player.
- VCR 1 : Selects the video component connected to the VCR 1 jacks.
- VCR 2 : Selects the video component connected to the VCR 2 jacks.
- TV/DBS : Selects the DBS tuner.
 - Does not work for selecting TV.
- VIDEO : Selects the video component connected to the VIDEO jacks.
- CD* : Selects the CD player.
- PHONO* : Selects the turntable.
- TAPE/MD* : Selects the cassette deck (or the MD recorder).
- CDR* : Selects the CD recorder.
- FM* : Select an FM broadcast.
- AM* : Selects an AM broadcast.

Notes:

- When you press one of the source selecting buttons on the remote control marked with an asterisk (*), the receiver automatically turns on. If you turn on the receiver with MAIN ROOM/SUB ROOM (LEARN/TRANSMIT) selector set to "MAIN ROOM", press SUB ROOM ON/OFF to activate the sub-room operations.
 - Pressing one of the audio source selecting buttons on the remote control (except FM and AM) with the MAIN ROOM/SUB ROOM (LEARN/TRANSMIT) selector set to "SUB ROOM" while the receiver is turned on but the sub-room is turned off, the sub-room is turned on with the audio source selected.
- You cannot select the following as the sub-room source:
 - "TV"
 - "DVD MULTI"
 - Any digital input
 You can only select the analog input as the sub-room source. (If analog connections have not been done, no sound comes out of the sub-room speakers.)

Adjusting the Sub-Room Volume

On the unit:

To increase the volume, turn MASTER VOLUME clockwise.

To decrease the volume, turn it counterclockwise.

- When you turn MASTER VOLUME rapidly, the volume level also changes rapidly.
- When you turn MASTER VOLUME slowly, the volume level also changes slowly.

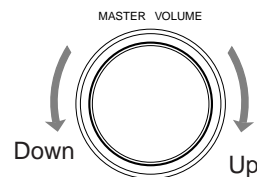

From the remote control:

To increase the volume, press VOLUME +.

To decrease the volume, press VOLUME -.

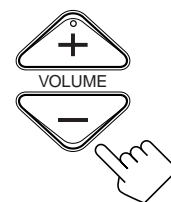

CAUTIONS:

- Always set the volume to the minimum before starting any source. If the volume is set at a high level, the sudden blast of sound energy can permanently damage your hearing and/or ruin your speakers.
- Be careful not to turn up the volume so high when controlling the receiver without listening to the playback sound. For example, when adjusting the volume level in the sub-room from the main room.

Notes:

- The volume level can be adjusted within the range of "– – – dB" (minimum) to "+18.0 dB" (maximum).
- With "SUBROOM PREOUT" set to "FIXED" (see page 40), no sounds come out of the SUB ROOM PREOUT jacks if the volume level is set to "– – – dB." If this case, increasing the volume level will enable the sound output through the SUB ROOM PREOUT jacks.

Activating the Sub-Room Front Speakers

This section is **NOT** applicable to those who connect the sub-room front speakers to the SUB ROOM PREOUT jacks using another amplifier (see page 17).

Before you start, remember...

- When shipped from the factory, both pairs of the front speakers have been set to be used in the main room. To use the front speakers connected to the FRONT 2/SUB ROOM SPEAKERS terminals in the sub-room, see “Preparing for the Sub-Room Operations—SUB ROOM” on page 40.

On the unit ONLY:

Press SPEAKERS 2/SUB ROOM to activate the sub-room front speakers.

The SUB ROOM speaker indicator lights up on the display.

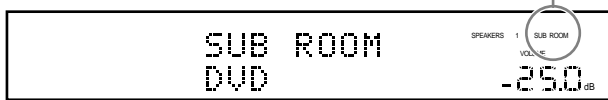

To deactivate the sub-room front speakers, press SPEAKERS 2/SUB ROOM again.

The SUB ROOM speaker indicator goes off.

Note:

If the center speaker or surround speakers are used for the Surround/DSP mode (see pages 46 and 50) for the main room operations, the SPEAKERS 2/SUB ROOM button does not work.

For those who connect the sub-room front speakers to the SUB ROOM PREOUT jacks using another amplifier (see page 17).

You have to determine how to adjust the volume level through the sub-room front speakers. (See “Preparing for the Sub-Room Operations—SUB ROOM” on page 40 for more details.)

To use the sub-room front speakers

- 1 Turn on the other amplifier connected to the SUB ROOM PREOUT jacks.
- 2 Adjust the volume level of sub-room front speakers either on the other amplifier or on this receiver (depending on the SUB PREOUT setting on the SUB ROOM submenu).

Muting the Sub-Room Sound

From the remote control ONLY:

Press **MUTING** to mute the sound through the sub-room front speakers.



The volume level indicator goes off.

To restore the sound, press **MUTING** again so that the volume level indicator appears on the display.

- Turning **MASTER VOLUME** on the unit or pressing **VOLUME +/-** on the remote control also restores the sound.

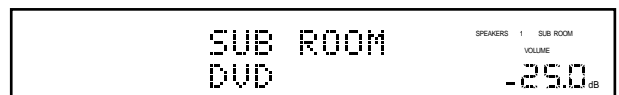

Note:

Sounds through the sub-room speakers connected to the SUB ROOM PREOUT jacks are also muted.

Receiving Radio Broadcasts

You can browse through all the stations or use the preset function to go immediately to a particular station.



Indicates the functions YOU CAN ALSO USE when the receiver is ready for the sub-room operations.

IMPORTANT:

Check to see if the following before or while using the buttons and controls.

For the main room operations:

The MAIN ROOM ON/OFF lamp on the unit is lit .

For the sub-room operations:

The SUB ROOM ON/OFF lamp on the unit is lit.

• When using the unit:

- For the main room operations: “SUB ROOM” is not shown in the main display.
- For the sub-room operations: “SUB ROOM” is shown in the main display.
- Press DOOR DOWN to use the buttons inside the front door.
- To close the front door, press DOOR UP.

DOOR
DOWN



• When using the remote control:

When operating the receiver using the remote control, the display on the unit always shows the main room source information though you are operating it for the sub-room source.

- Set the MAIN ROOM/SUB ROOM (LEARN/TRANSMIT) selector to “MAIN ROOM” or “SUB ROOM” correctly.
- Check the indication shown on the remote’s display when you press a button—this indicates the remote control operation mode together with multi-room operation mode (either MAIN ROOM or SUB ROOM) for a while (10 or 5 seconds).

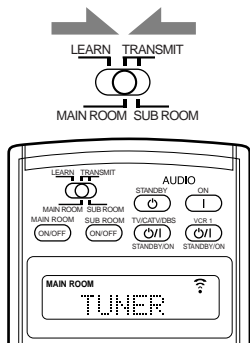

Ex. When you press FM with MAIN ROOM/SUB ROOM (LEARN/ TRANSMIT) selector set to “MAIN ROOM.”

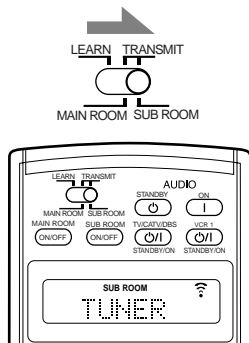

Ex. When you press FM with MAIN ROOM/SUB ROOM (LEARN/ TRANSMIT) selector set to “SUB ROOM.”

Tuning into Stations Manually



On the unit:

1. Press FM or AM.

The last received station is tuned in.

When operating for the main room

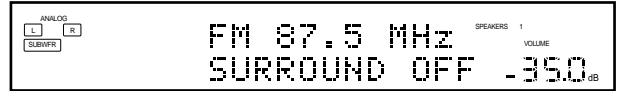

When operating for the sub-room

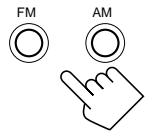
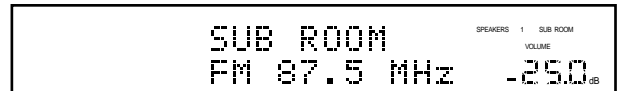

2. Press UP or DOWN (inside the front door) until you find the frequency you want.

- Pressing UP increases the frequencies.
- Pressing DOWN decreases the frequencies.

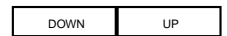

From the remote control:

1. Press FM or AM.

The last received station is tuned in.

2. Press TUNING UP or TUNING DOWN until you find the frequency you want.

- Pressing TUNING UP increases the frequencies.
- Pressing TUNING DOWN decreases the frequencies.

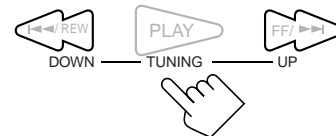
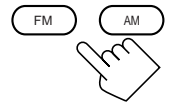

Notes:

- When a station of sufficient signal strength is tuned in, the TUNED indicator lights up on the display.
- When an FM stereo program is received, the STEREO indicator also lights up.
- When you hold the button (and release it) in step 2, the frequency keeps changing until a station is tuned in.
- You can only select the same station of the same band (FM or AM) both for the main room and sub-room operations. If you change the station for the sub-room, it also changes for the main room (and vice versa: indications in the main display also change). This also means that if you change the station for the sub-room while recording a broadcasting program in the main room, recording in the main room will be interrupted.

Using Preset Tuning

Once a station is assigned to a channel number, the station can be quickly tuned in. You can preset up to 30 FM and 15 AM stations.

To store the preset stations

Before you start, remember...

- There is a time limit in doing the following steps. If the setting is canceled before you finish, start from step 1 again.

On the unit ONLY:

1. Tune into an FM or AM station you want to preset (see “Tuning into Stations Manually” on page 31).

- If you want to store the FM reception mode for an FM station, select the FM reception mode you want. See “Selecting the FM Reception Mode.”

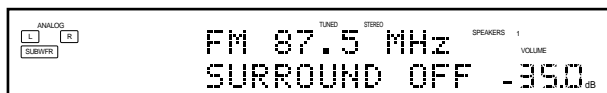

2. Press SET (inside the front door).

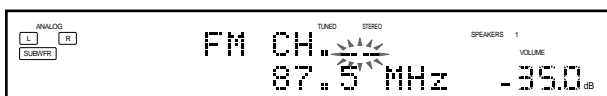
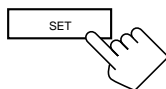

The channel number position starts flashing on the display for about 10 seconds.

3. Press RIGHT or LEFT (inside the front door) to select a channel number while the channel number position is flashing.

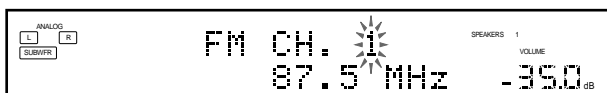
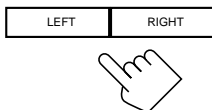

4. Press SET again while the selected channel number is flashing on the display.

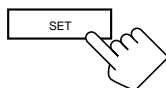

The selected channel number stops flashing.
The station is assigned to the selected channel number.

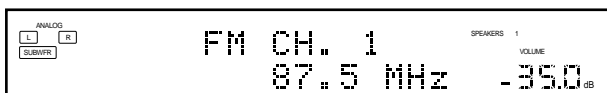

5. Repeat steps 1 to 4 until you store all the FM and AM stations you want.

To erase a stored preset station

Storing a new station on a used number erases the previously stored one.

To tune into a preset station



On the unit:

1. Press FM or AM.

The last received station is tuned in.

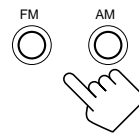

2. Press RIGHT or LEFT (inside the front door) until you find the channel you want.

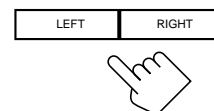

- Pressing RIGHT increases the numbers.
- Pressing LEFT decreases the numbers.

From the remote control:

1. Press FM or AM.

The last received station is tuned in.

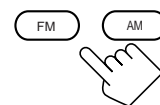

2. Press the 10 keys to select a preset channel number.

- For channel number 5, press 5.
- For channel number 15, press +10 then 5.
- For channel number 20, press +10 then 10.
- For channel number 30, press +10, +10, then 10.



Note:

You can only select the same station of the same band (FM or AM) both for the main room and sub-room operations. If you change the station for the sub-room, it also changes for the main room (and vice versa: indications in the main display also change). This also means that if you change the station for the sub-room while recording a broadcasting program in the main room, recording in the main room will be interrupted.

Selecting the FM Reception Mode

When an FM stereo broadcast is hard to receive or noisy

You can change the FM reception mode while receiving an FM broadcast.

- You can store the FM reception mode for each preset station.

Press FM MODE.

- Each time you press the button, the FM reception mode alternates between “AUTO MUTING” and “MONO.”

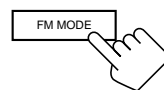

On the unit
(inside the front door)



On the remote control

AUTO MUTING: When a program is broadcasted in stereo, you will hear stereo sound; when in monaural, you will hear monaural sounds. This mode is also useful to suppress static noise between stations. The AUTO MUTING indicator lights up on the display.

MONO: Reception will be improved although you will lose the stereo effect. In this mode, you will hear noise while tuning into the stations. The AUTO MUTING and STEREO indicators go off from the display.

Note:

When you press FM MODE on the remote control, be sure that “TUNER” appears on the remote’s display. If not, press FM first, then press FM MODE.

Basic Settings

Some of the following settings are required after connecting and positioning your speakers, while others will make operations easier.

When performing the basic settings, it is recommended to use the remote control so that you can show the on-screen display menu on the TV.

- When using the buttons on the unit, you can perform the same settings referring to the indications on the unit's display. (The following on-screen display menus cannot be shown if you use the buttons on the unit.)
- Basic setting operations are only possible while the receiver is ready for the main room operations.

Setup Menu Configuration

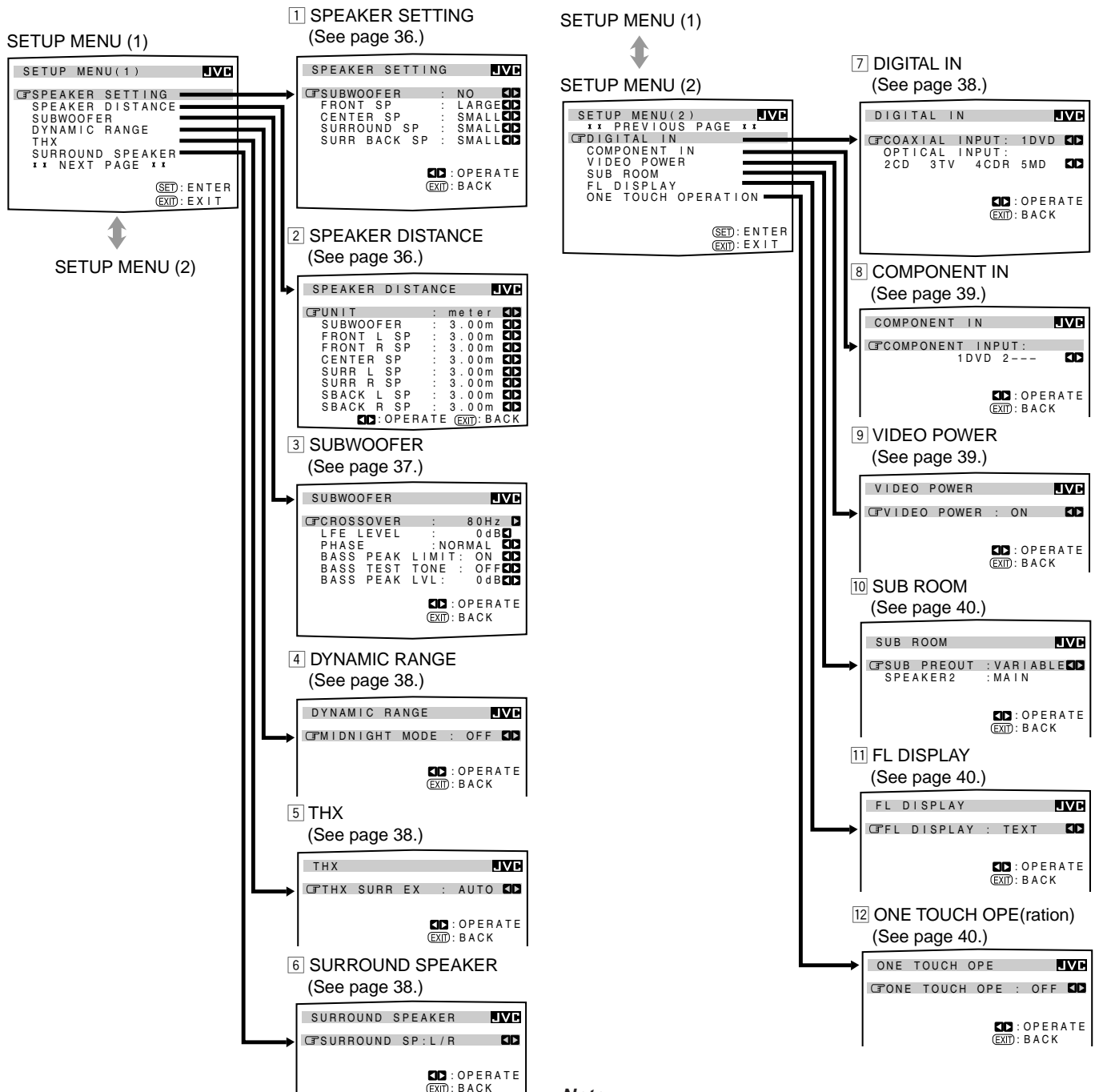

NOTICE—

- Items on the menus shown above are all set to the initial values when shipped from the factory.
- Some of the menus or some items on the menu cannot be shown or cannot be adjusted. (For details, see the respective explanation in this section.)

Note:

When performing the basic settings viewing the indications on the main unit's display, the indications are slightly different from what is shown on the on-screen display.

This is because of the limited number of characters shown on the main unit's display.

- Ex. • "SPEAKER SETTING" is shown as "SP SETTING" on the main unit's display.
- "SPEAKER DISTANCE" is shown as "SP DISTANCE" on the main unit's display.

IMPORTANT:

Check to see if the following before or while using the buttons and controls.

For the main room operations:

The MAIN ROOM ON/OFF lamp on the unit is lit.

When using the unit:

- "SUB ROOM" is not shown in the main display.
- Press DOOR DOWN to use the buttons inside the front door.
To close the front door, press DOOR UP.



When using the remote control:

- Set the MAIN ROOM/SUB ROOM (LEARN/TRANSMIT) selector to "MAIN ROOM."
- Check the indication shown on the remote's display when you press a button—this indicates the remote control operation mode together with multi-room operation mode (either MAIN ROOM or SUB ROOM) for a while (10 or 5 seconds).

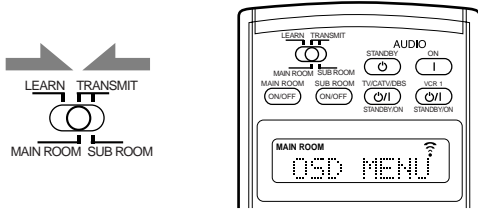

Ex. When you press SETUP MENU with MAIN ROOM/SUB ROOM (LEARN/TRANSMIT) selector set to "MAIN ROOM."

Operation through On-Screen Display Menus

To do the basic settings for this receiver, use the remote control so that you can utilize the on-screen display menus in order to finish important settings easily while viewing these menus.

Menu operation buttons

From the remote control:

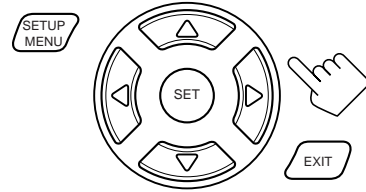

Button	To do
SETUP MENU	display or erase the Setup Menu.
▽ / △	select a submenu item on the Setup Menu or on submenus (downwards or upwards).
SET	move to the selected submenu screen.
< / >	select the desired setting on a submenu.
EXIT	exit from menu operations or return to the previous menu.

- When no operation is done for about 1 minute, the on-screen menu (as well as the indications in the unit's main display) will disappear.

On the unit:

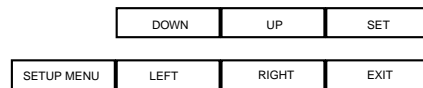

(inside the front door)

Button	To do
SETUP MENU	display or erase the Setup Menu.
DOWN/UP	select a submenu item on the Setup Menu or on submenus (downwards or upwards).
SET	move to the selected submenu screen.
LEFT/RIGHT	select the desired setting on a submenu.
EXIT	exit from menu operations or return to the previous menu.

- When no operation is done for about 5 seconds, the indications on the unit's display will disappear.

The buttons that can be used on the menus are shown on the screen. You can perform menu operation with these usable buttons.

SETUP MENU (1) JVC

⏏ SPEAKER SETTING

SPEAKER DISTANCE

SUBWOOFER

DYNAMIC RANGE

THX

SURROUND SPEAKER

* * NEXT PAGE * *

(SET): ENTER
(EXIT): EXIT

Usable buttons

SPEAKER SETTING JVC

⏏ SUBWOOFER : NO

FRONT SP : LARGE

CENTER SP : SMALL

SURROUND SP : SMALL









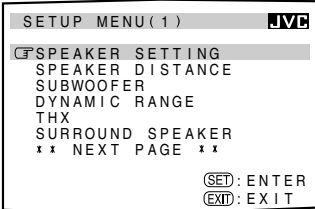
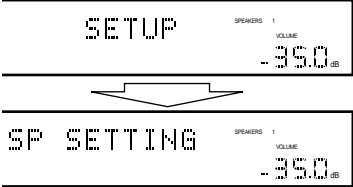

SURR BACK SP : SMALL

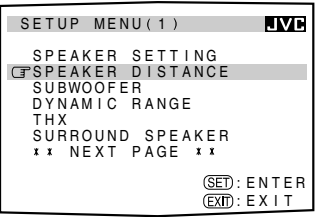
(OP): OPERATE
(EXIT): BACK

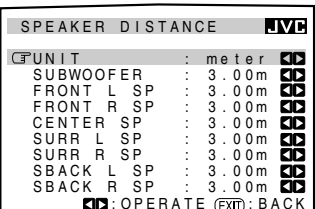
Usable buttons

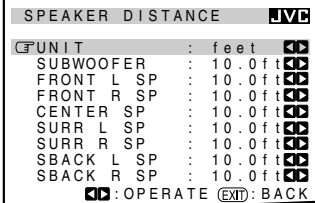
Menu Operating Procedure

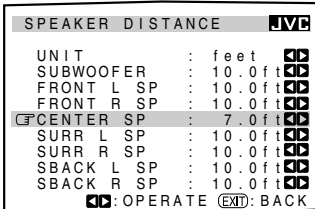
Ex. When setting the speaker distance

Operations	On the TV screen	On the main unit's display
<p>1. Press SETUP MENU.</p>		
<p>2. Press ▾ or ▲ (DOWN or UP) repeatedly to select the desired submenu.</p> <ul style="list-style-type: none"> In this example, select "SPEAKER DISTANCE" submenu. 	<p>Move  to "SPEAKER DISTANCE."</p> 	<p>Press the button until "SP (speaker) DISTANCE" appears.</p> 
<p>3. Press SET.</p>		
<p>4. Set a desired item on the submenu.</p> <ol style="list-style-type: none"> Press ▾ or ▲ (DOWN or UP) repeatedly to select an item. Press ▶ or ◀ (RIGHT or LEFT) to set the item. <ul style="list-style-type: none"> In this example, set "UNIT" to "feet" for indicating the speaker distance. 		
<p>5. Set other items on the same submenu if necessary.</p> <ol style="list-style-type: none"> Press ▾ or ▲ (DOWN or UP) repeatedly to select another item on the same submenu if necessary. Press ▶ or ◀ (RIGHT or LEFT) to set the item. <ul style="list-style-type: none"> In this example, set the center speaker distance. 		

To move between the SETUP MENU (1) and (2)

- By simply pressing ▾ (or DOWN) repeatedly on the SETUP MENU (1), you can go to the SETUP MENU (2).
- By simply pressing ▲ (or UP) repeatedly on the SETUP MENU (2), you can go back to the SETUP MENU (1).

To return to the previous screens

Press EXIT.

Each time you press the button, the on-screen display menu returns to the one previously displayed. (On the unit's main display, the indications also change accordingly.)

To erase the menu (to return to the regular screen)

Press SETUP MENU.

* "SETUP" appears only when using the button on the unit.
 ** When using the buttons on the unit, the last item selected will appear; on the other hand, when using the remote control, the first-listed item on the menu will always appear.

Setting the Speakers —SPEAKER SETTING (1)

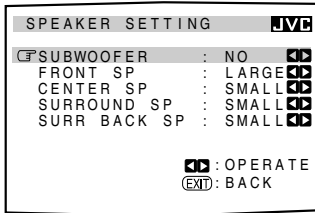

To obtain the best possible surround sound of the Surround and DSP modes in the main room, you have to register the information about the speaker arrangement after all connections are completed.

For subwoofer:

Select one of the following.

YES : Select this when a subwoofer is connected.

NO : Select this when no subwoofer is used.

For front speakers, center speaker, surround speakers, and surround back speakers:

Select one of the following.

LARGE : Select this when the speaker size is relatively large.

SMALL : Select this when the speaker size is relatively small.

NONE : Select this when you have not connected a speaker. (Not selectable for the front speakers)

Notes:

- Keep the following comment in mind as reference when adjusting.
 - If the size of the cone speaker unit built in your speaker is greater than 12 cm (4 3/4 inches), select "LARGE," and if it is smaller than 12 cm (4 3/4 inches), select "SMALL."
- If you have selected "NO" for the subwoofer, you can only select "LARGE" for the front speakers.
- If you have selected "SMALL" for the front speakers, you cannot select "LARGE" for the center, surround, and surround back speakers.
- If you have selected "SMALL" for the surround speakers, you cannot select "LARGE" for the surround back speakers.
- If you have selected "NONE" for the surround speakers, the surround back speakers are fixed to "NONE."

Setting the Speaker Distance —SPEAKER DISTANCE (2)

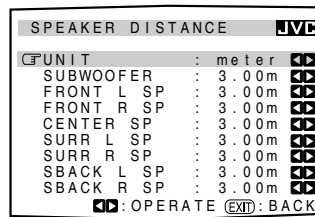

The distance from your listening point to the speakers is another important element to obtain the best possible surround sound of the Surround and DSP modes. You need to set the distance from your listening point to the speakers.

By referring to the speaker distance setting, this unit automatically sets the delay time of the sound through each speaker so that sounds through all the speakers can reach you at the same time.

For measuring unit:

Select one of the following.

meter : Select this to set the distance by meter.

feet : Select this to set the distance by feet.

For each speaker:

Set the distance from the listening point within the range of **0.30 m (1.0 ft) to 9.00 m (30.0 ft)**, in 0.15 m (0.5 ft) intervals.

Notes:

- You cannot set the speaker distance for the speaker you have selected "NO" or "NONE" for on the SPEAKER SETTING submenu.
- This setting is not valid for the DVD MULTI playback mode.

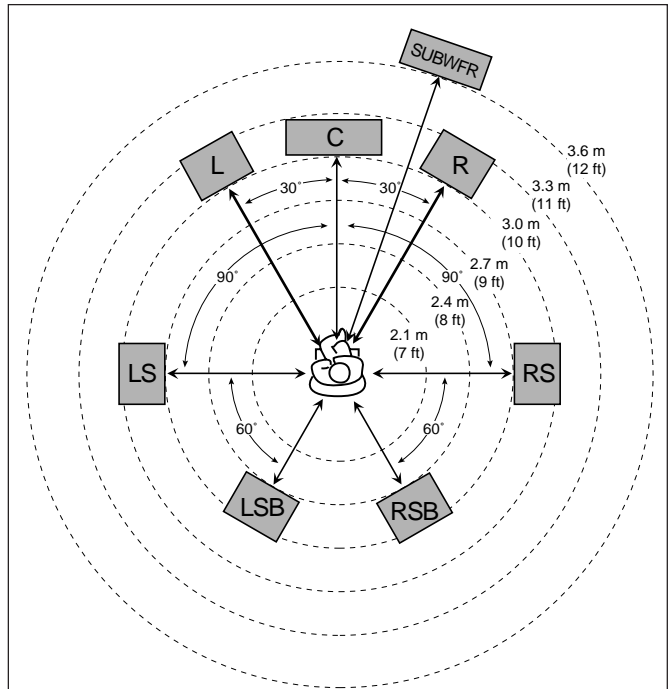

EX. In the above case, set the speaker distance as follows:

Subwoofer (SUBWFR)	SUBWOOFER:	3.60 m (12.0 ft)
Left front (L)	FRONT L SP:	3.00 m (10.0 ft)
Right front (R)	FRONT R SP:	3.00 m (10.0 ft)
Center (C)	CENTER SP:	3.00 m (10.0 ft)
Left surround (LS)	SURR L SP:	2.40 m (8.0 ft)
Right surround (RS)	SURR R SP:	2.40 m (8.0 ft)
Left surround back (LSB)	SBACK L SP:	2.70 m (9.0 ft)
Right surround back (RSB)	SBACK R SP:	2.70 m (9.0 ft)

Setting the Bass Sounds—SUBWOOFER (3)

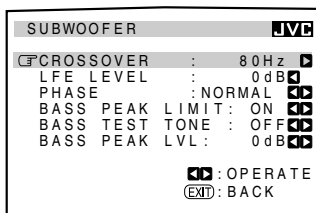

On this submenu, you can adjust subwoofer and bass sounds precisely according to your preference.

Setting the crossover frequency:

When you use a subwoofer, you can select the cutoff frequency for the small speakers used.

Select one of the crossover frequency levels according to the size of the small speaker connected.

- | | |
|--------------|---|
| 80Hz | : Select this when the cone speaker unit built in the speaker system is about 12 cm (4 ³ / ₄ inches). |
| 100Hz | : Select this when the cone speaker unit built in the speaker system is about 10 cm (3 ¹⁵ / ₁₆ inches). |
| 120Hz | : Select this when the cone speaker unit built in the speaker system is about 8 cm (3 ³ / ₁₆ inches). |

Notes:

- Use the above comments as reference when adjusting.
- If you have selected "LARGE" for all activated speakers, this function will be set to "OFF."
- If "SUBWOOFER" is set to "NO" on the SPEAKER SETTING submenu, this function is not available.
- Crossover frequency is not valid for the DVD MULTI playback mode, ALL CH STEREO mode and 3D HEADPHONE mode.
- If Line Direct is in use, this function does not take effect.

Setting the low frequency effect attenuator (LFE):

If the bass sound is distorted while playing back software encoded with Dolby Digital or DTS Surround, set the LFE level to eliminate distortion.

Adjust the LFE level within the range of **-20 dB to 0 dB**. (Normally select "0 dB.")

- Each time you press ▷ (RIGHT) or ◁ (LEFT), the LFE level changes by ± 1 dB.

Notes:

- If "SUBWOOFER" is set to "NO" on the SPEAKER SETTING submenu, this function is not available.
- Low frequency effect attenuator is not valid for THX Surround EX and the DVD MULTI playback mode.

Changing the sound phase:

If the sound output through the subwoofer is not satisfactory, changing the phase will give you a different result.

Select one of the following:

NORMAL : Normally select this.

REVERSE : Select this to reverse the phase.

Note:

If "SUBWOOFER" is set to "NO" on the SPEAKER SETTING submenu, this function is not available.

Using the Bass Peak Limiter:

When this setting is "ON," Bass Peak Limiter functions so that sounds exceeding the preset peak level (see below) will be cut off.

When this setting is "ON," you can set the bass peak level using the bass test tone (see below) to eliminate bass sound distortion while playing back software encoded with Dolby Digital or DTS Surround.

Select one of the following:

ON : Normally select this.

OFF : Select this when not using the Bass Peak Limiter.

Outputting the bass test tone:

Only when "BASS PEAK LIMITER" is "ON," you can output the bass test tone through the subwoofer and/or other speakers (depending on your settings on the SPEAKER SETTING submenu), and adjust the bass peak level (see below).

Select one of the following:

ON : Select this to output the bass test tone.

OFF : Select this to stop the bass test tone.

Note:

If "BASS PEAK LIMITER" is set to "OFF," this function is not available.

Setting the bass peak level:

Only when "BASS PEAK LIMITER" is "ON," you can set the bass peak level so that sounds exceeding the peak level will be cut off to prevent the bass sound distortion.

Adjust the bass peak level within the range of **-12 dB to +18 dB**. (Normally select "0 dB.")

- While listening to the bass test tone, press and hold ▷ (RIGHT) to increase the bass test tone output level, and stop increasing the level just before the test tone is distorted. The level where you stop can be memorized as the bass peak level.
- Each time you press ▷ (RIGHT) or ◁ (LEFT), the bass peak level changes by ± 1 dB.

Note:

When you set "BASS TEST TONE" to "ON," the bass peak level is reset to "— dB" (no sound).

Setting the Dynamic Range —DYNAMIC RANGE (4)

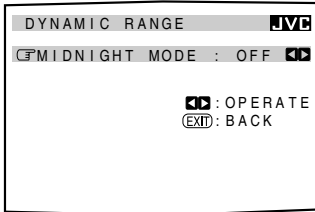

Using the Midnight mode, you can enjoy a powerful sound at night even at a low volume level.

Setting the Midnight mode:

Select one of the following:

- 1 : Select this when you want to reduce the dynamic range a little. The MIDNIGHT MODE indicator lights up on the display.
 - 2 : Select this when you want to apply the compress effect fully (useful at midnight). The MIDNIGHT MODE indicator lights up on the display.
- OFF** : Select this when you want to enjoy surround with its full dynamic range (no effect applied). The MIDNIGHT MODE indicator goes off from the display.

Notes:

- This function is applied only to the main room sources.
- If Line Direct is in use, Midnight mode is temporarily canceled.
- Midnight mode is not valid for the THX Surround modes and DVD MULTI playback mode.

Preparing for THX Surround Modes—THX (5)

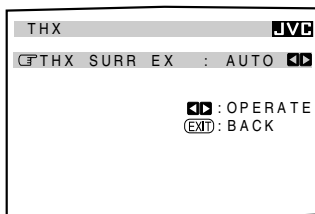

On this submenu screen, you can preset when and how to apply the THX Surround EX to playback software when you press THX ON/OFF button. (See page 48.)

Setting THX Surround EX:

Select one of the following:

- AUTO** : This unit automatically selects either “THX SURR EX” or “THX CINEMA” according to the playback software when you press THX ON/OFF.
- “THX SURR EX” is selected for software encoded with Dolby Digital EX (only if the Dolby Digital EX identification mark is recorded on the disc).
 - “THX CINEMA” is selected except for the above case.
- ON** : This unit automatically selects either “THX SURR EX” or “THX CINEMA” according to the playback software when you press THX ON/OFF.
- “THX SURR EX” is selected for multichannel digital software.
 - “THX CINEMA” is selected except for the above case.
- OFF** : When you press THX ON/OFF, “THX CINEMA” is always selected for any software.

Note:

When “SURR BK SP” is set to “NONE” on the SPEAKER SETTING submenu, this submenu is not available.

Setting the Surround Sound Output —SURROUND SPEAKER (6)

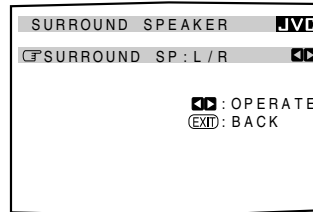

On this submenu screen, you can preset which surround speakers to use to output the surround sounds (except for the THX Surround EX, DAP modes, and DVD MULTI playback mode).

Setting the surround speakers to use

Select one of the following:

- L/R** : Select this to use only the left and right surround speakers.
- BACK** : Select this to use only the surround back speakers.
- L/R+BACK** : Select this to use both the surround speakers and surround back speakers.

Note:

When “SURR BACK SP” is set to “NONE” on the SPEAKER SETTING menu, this submenu is not available.

Setting the Digital Input Terminals —DIGITAL IN (7)

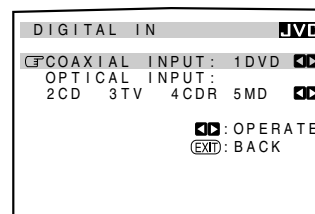

When you use the digital input terminals, you have to register what components you have connected to the digital input terminals.

Setting the component connected to the digital coaxial terminal

Set the component connected to the digital coaxial (DIGITAL IN 1) terminal.

- Each time you press > (RIGHT) or < (LEFT), the digital component name changes as follows:

1DVD ⇄ 1CD ⇄ 1TV (or 1DBS*) ⇄ 1CDR ⇄ 1MD**
⇄ 1VCR1 ⇄ (back to the beginning)

* If you have changed the source name from “TV” to “DBS,” “DBS” appears (see page 25).

** If you want to connect an MD recorder to the digital input terminal, change the source name to “MD” from “TAPE” (see page 25).

■ **Setting the component connected to the digital optical terminals**

Set the components connected to the digital optical terminals.

- Each time you press ▷ (RIGHT) or ◁ (LEFT), the digital component names change as follows:

When “COAXIAL INPUT” is set to “DVD”

2 CD 3 TV (or DBS*) 4 CDR 5 MD ⇄
 2 CD 3 TV (or DBS*) 4 CDR 5 VCR1 ⇄
 2 CD 3 TV (or DBS*) 4VCR1 5 MD** ⇄
 2 CD 3 VCR1 4 CDR 5 MD** ⇄
 2 VCR1 3 TV (or DBS*) 4 CDR 5 MD** ⇄
 (back to the beginning)

When “COAXIAL INPUT” is set to “CD”

2 DVD 3 TV (or DBS*) 4 CDR 5 MD ⇄
 2 DVD 3 TV (or DBS*) 4 CDR 5 VCR1 ⇄
 2 DVD 3 TV (or DBS*) 4 VCR1 5 MD** ⇄
 2 DVD 3 VCR1 4 CDR 5 MD** ⇄
 2 VCR1 3 TV (or DBS*) 4 CDR 5 MD** ⇄
 (back to the beginning)

When “COAXIAL INPUT” is set to “TV” or “DBS”*

2 CD 3 DVD 4 CDR 5 MD** ⇄
 2 CD 3 DVD 4 CDR 5 VCR1 ⇄
 2 CD 3 DVD 4 VCR1 5 MD** ⇄
 2 CD 3 VCR1 4 CDR 5 MD** ⇄
 2 VCR1 3 DVD 4 CDR 5 MD** ⇄
 (back to the beginning)

When “COAXIAL INPUT” is set to “CDR”

2 CD 3 TV (or DBS*) 4 DVD 5 MD** ⇄
 2 CD 3 TV (or DBS*) 4 DVD 5 VCR1 ⇄
 2 CD 3 TV (or DBS*) 4 VCR1 5 MD** ⇄
 2 CD 3 VCR1 4 DVD 5 MD ⇄
 2 VCR1 3 TV (or DBS*) 4 DVD 5 MD** ⇄
 (back to the beginning)

When “COAXIAL INPUT” is set to “MD”**

2 CD 3 TV (or DBS*) 4 CDR 5 DVD ⇄
 2 CD 3 TV (or DBS*) 4 CDR 5 VCR1 ⇄
 2 CD 3 TV (or DBS*) 4 VCR1 5 DVD ⇄
 2 CD 3 VCR1 4 CDR 5 DVD ⇄
 2 VCR1 3 TV (or DBS*) 4 CDR 5 DVD ⇄
 (back to the beginning)

When “COAXIAL INPUT” is set to “VCR1”

2 CD 3 TV (or DBS*) 4 CDR 5 MD** ⇄
 2 CD 3 TV (or DBS*) 4 CDR 5 DVD ⇄
 2 CD 3 TV (or DBS*) 4 DVD 5 MD** ⇄
 2 CD 3 DVD 4 CDR 5 MD** ⇄
 2 DVD 3 TV (or DBS*) 4 CDR 5 MD** ⇄
 (back to the beginning)

- * If you have changed the source name from “TV” to “DBS,” “DBS” appears (see page 25).
- ** If you have connected an MD recorder to the digital input terminal, change the source name to “MD” from “TAPE” (see page 25).

Note:

When shipped from the factory, the DIGITAL IN terminals can be used as the digital input for the following components:

- DIGITAL 1 (coaxial): For DVD player
- DIGITAL 2 (optical): For CD player
- DIGITAL 3 (optical): For digital TV broadcast tuner
- DIGITAL 4 (optical): For CD recorder
- DIGITAL 5 (optical): For MD recorder

■ **Preparing for the Component Video Input —COMPONENT IN (8)**

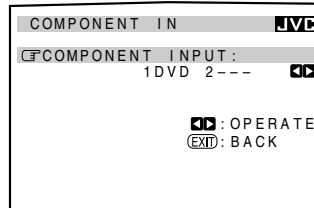

When you use the component video input, you have to register what components you have connected to the component input terminals. Without setting this correctly, you cannot view the correct input on the TV.

■ **Setting the component video input terminals**

Select the components connected to the COMPONENT 1 (DVD) and COMPONENT 2 video input terminals.

- Each time you press ▷ (RIGHT) or ◁ (LEFT), the component name changes as follows:

1 DVD 2 --- ⇄ 1 DVD 2 DBS* ⇄
 1 DVD 2 VCR1 ⇄ 1 DBS* 2 --- ⇄
 1 DBS* 2 VCR1 ⇄ 1 VCR1 2 --- ⇄
 1 --- 2 --- ⇄ (back to the beginning)

Notes:

- * When you have connected the DBS tuner to the COMPONENT 1 (DVD) or COMPONENT 2 video input terminals, change the source name from “TV” to “DBS.” To change the source name, see “Changing the Source Name” on page 25.
- When you have not connected any component, select “---.”
- If you have not made this setting correctly, the AV COMPU LINK remote control system cannot operate properly. (See page 61.)

■ **Turning On and Off the Video Output —VIDEO POWER (9)**

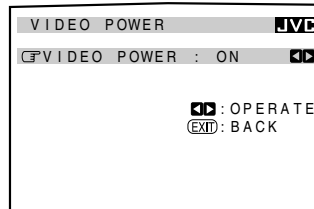

On this submenu screen, you can turn on or off the power supply to the video output circuit built in this unit.

■ **Turning on or off the power supply to the video circuit**

Select one of the following:

- ON** : Normally select this.
Power is supplied to the built-in video output circuit.
- OFF** : Select this not to supply power to the built-in video output circuit while playing an audio source.
With this setting, noise will be reduced while playing an audio source.

Note:

Even if “VIDEO POWER” is set to “OFF,” power will be supplied to the video circuit when on-screen display menus are used.

■ Preparing for the Sub-Room Operations —SUB ROOM (10)

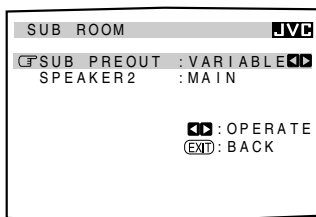

On this submenu, you can determine the output signal type through the SUB ROOM PREOUT jacks, and the usage of the speaker connected to the FRONT SPEAKER2/SUB ROOM terminals.

■ Setting the signal output type through the SUB ROOM PREOUT jacks

When connecting the sub-room front speakers to the SUB ROOM PREOUT jacks through another amplifier (see page 17), determine how to adjust the volume level in the sub-room.

Select one of the following:

VARIABLE : Select this when you want to adjust the sub-room volume level using the MASTER VOLUME control on this unit (or VOLUME +/- on this remote control).

FIXED : Select this when you want to adjust the sub-room volume level using the amplifier connected to the SUB ROOM PREOUT jacks.

- The MASTER VOLUME control on this unit (or VOLUME +/- on this remote control) cannot adjust the sub-room volume level.

■ Setting the speakers 2

When connecting the speakers to the FRONT SPEAKERS 2/SUB ROOM, determine the speaker usage—whether you use these speakers as the second front speakers in the main room or as the front speakers in the sub-room.

MAIN : Select this when you use these speakers as the second front speakers in the main room.

SUB : Select this when you use these speakers as the front speakers in the sub-room.

■ Showing the Text Information on the Display—FL DISPLAY (11)

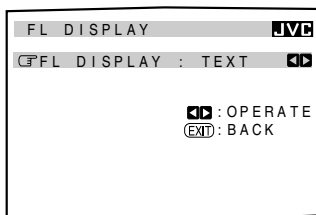

When you have connected an MD recorder or CD player equipped with TEXT COMPU LINK remote control system (see page 56), you can show the text information, such as disc title or track title, on the display of this receiver.

■ Turning on or off the text information display

Select one of the following:

NORMAL : Source name and Surround/DSP mode appear during play.

TEXT : Text information appears during play.

Note:

Though you have selected "TEXT," the source name and Surround/DSP mode will appear while playing a disc that has no text information.

■ Memorizing the Volume Level for Each Source—ONE TOUCH OPE(ration) (12)

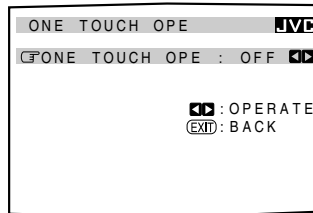

This unit memorizes many settings separately for each source. (See page 26.)

In addition, you can store the volume level for each source together with the other memorized settings.

■ Storing the volume level for each source

Select one of the following:

ON : Select this to store the volume level setting separately for each source. (The ONE TOUCH OPERATION indicator lights up on the main unit's display.)

This receiver memorizes the volume level—

- when you turn off the power,
- when you change the source,
- when you change the analog/digital input mode (see page 23), and
- when you turn on One Touch Operation.

OFF : Select this not to store the volume level setting.

To recall the volume level

With the ONE TOUCH OPERATION indicator lit, the volume level for the currently selected source is recalled when the source is selected.

To cancel the One Touch Operation

Set One Touch Operation to "OFF" so that the ONE TOUCH OPERATION indicator goes off.

Sound Adjustments

When performing the sound adjustments, it is recommended to use the remote control so that you can show the on-screen display menu on the TV.

- When using the buttons on the unit, you can perform the same settings referring to the indications shown on the main unit's display. (The following on-screen display menus cannot be shown if you use the buttons on the unit.)
- Sound adjustment operations are only possible while the receiver is ready for the main room operations.

Adjustment Menu Configuration

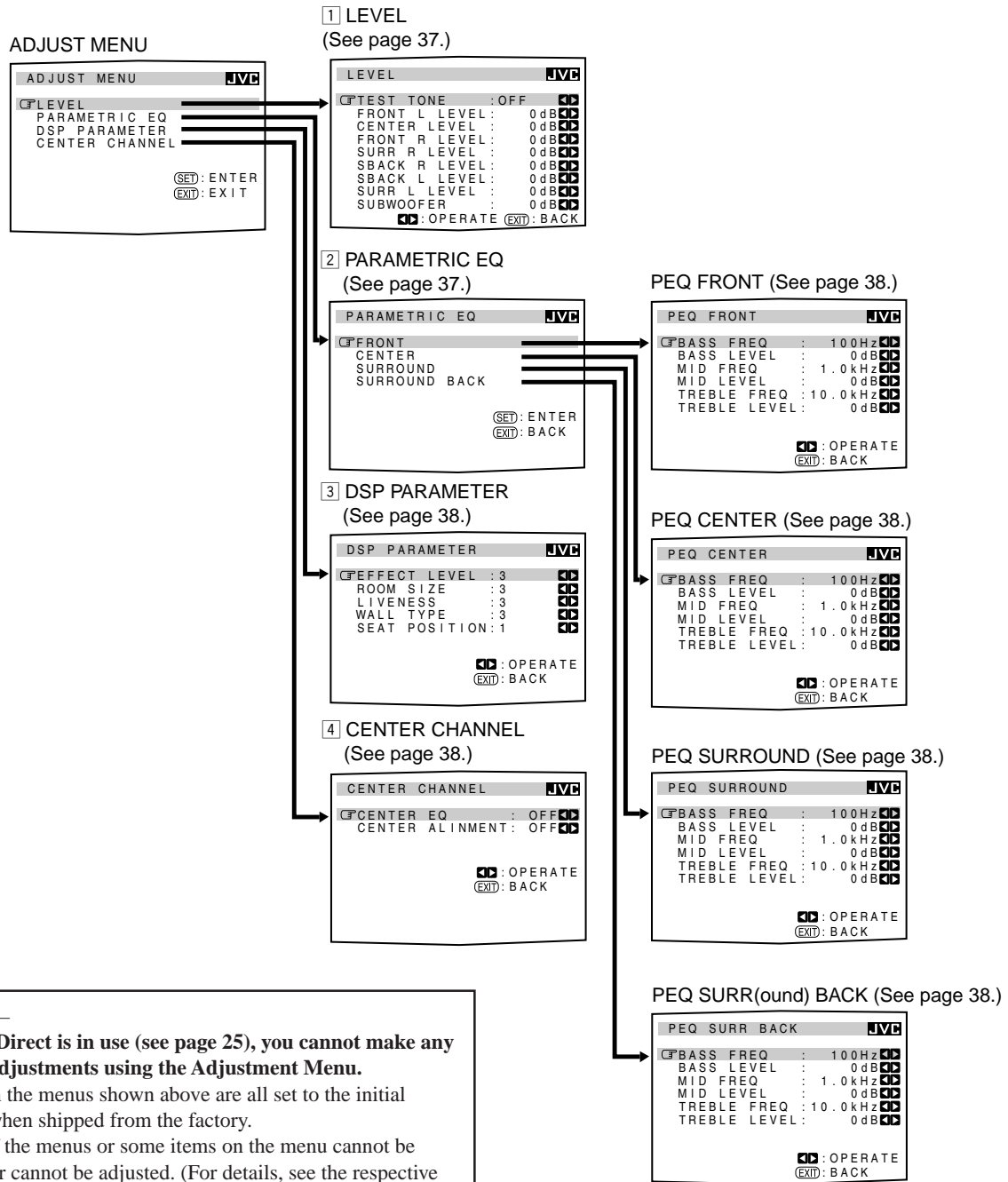

NOTICE—

- If Line Direct is in use (see page 25), you cannot make any sound adjustments using the Adjustment Menu.
- Items on the menus shown above are all set to the initial values when shipped from the factory.
- Some of the menus or some items on the menu cannot be shown or cannot be adjusted. (For details, see the respective explanation in this section.)

Note:

When performing sound adjustments viewing the indications on the main unit's display, the indications shown are slightly different from what is shown on the on-screen display.

This is because of the limited number of characters shown on the main unit's display.

- Ex. • "FRONT L LEVEL" is shown as "FRONT L LVL" on the main unit's display.
- "CENTER LEVEL" is shown as "CENTER LVL" on the main unit's display.

IMPORTANT:

Check to see if the following before or while using the buttons and controls.

For the main room operations:

The MAIN ROOM ON/OFF lamp on the unit is lit.

When using the unit:

- "SUB ROOM" is not shown in the main display.
- Press DOOR DOWN to use the buttons inside the front door.
To close the front door, press DOOR UP.



When using the remote control:

- Set the MAIN ROOM/SUB ROOM (LEARN/TRANSMIT) selector to "MAIN ROOM."
- Check the indication shown on the remote's display when you press a button—this indicates the remote control operation mode together with multi-room operation mode (either MAIN ROOM or SUB ROOM) for a while (10 or 5 seconds).

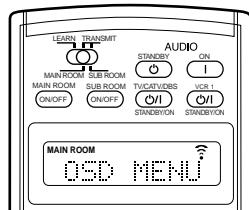
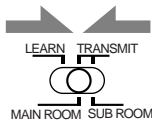

Ex. When you press ADJUST MENU with MAIN ROOM/SUB ROOM (LEARN/TRANSMIT) selector set to "MAIN ROOM."

Operation through On-Screen Display Menus

To make sound adjustments for this receiver, use the remote control so that you can utilize the on-screen display menus in order to finish important adjustments easily while viewing these menus.

Menu operation buttons

From the remote control:

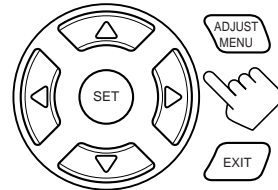

Button	To do
ADJUST MENU	display or erase the Adjustment Menu.
▽ / △	select a submenu item on the Adjustment Menu or on submenus (downwards or upwards).
SET	move to the selected submenu screen.
< / >	select the desired setting on a submenu.
EXIT	exit from menu operations or return to the previous menu.

- When no operation is done for about 1 minute, the on-screen menu (as well as the indications in the unit's main display) will disappear.

On the front panel:

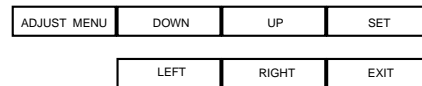

(inside the front door)

Button	To do
ADJUST MENU	display or erase the Adjustment Menu.
DOWN/UP	select a submenu item on the Adjustment Menu or on submenus (downwards or upwards).
SET	move to the selected submenu screen.
LEFT/RIGHT	select the desired setting on a submenu.
EXIT	exit from menu operations or return to the previous menu.

- When no operation is done for about 5 seconds, the indications on the unit's display will disappear.

The buttons that can be used on the menus are shown on the screen.
You can perform menu operation with these usable buttons.

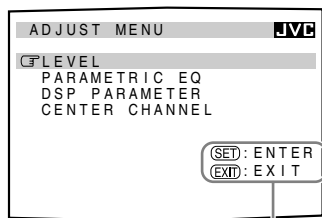



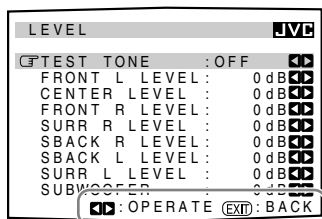



Usable buttons

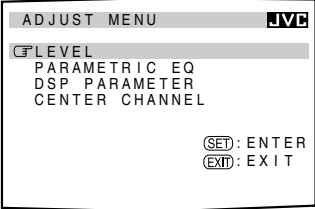
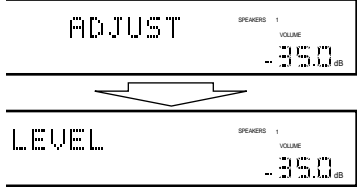

Usable buttons

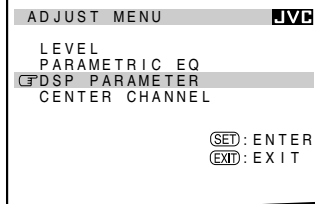
Menu Operating Procedure

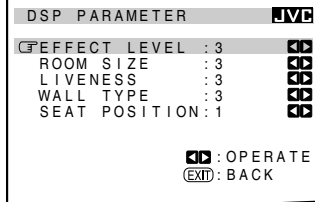
Ex. When adjusting a DSP parameter

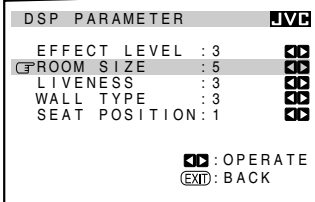
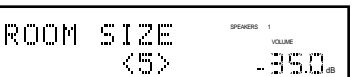
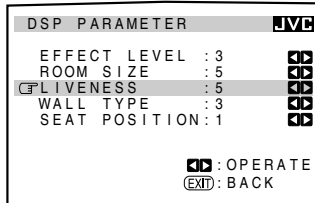
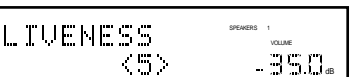
Operations	On the TV screen	On the main unit's display
1. Press ADJUST MENU.		
2. Press ▾ or ▲ (DOWN or UP) repeatedly to select the desired submenu. <ul style="list-style-type: none"> In this example, select "DSP PARAMETER" submenu. 	Move  to "DSP PARAMETER." 	Press the button until "DSP" appears. 
3. Press SET. <div data-bbox="113 1039 676 1151" style="border: 1px solid black; padding: 5px; margin-top: 10px;"> <p>When adjusting the parametric equalizer:</p> <p>Repeat steps 2 and 3 to select the items on the submenu, and to go to its adjustment screen.</p> </div>		
4. Set a desired item on the submenu. <ol style="list-style-type: none"> Press ▾ or ▲ (DOWN or UP) repeatedly to select an item. Press ▶ or ◀ (RIGHT or LEFT) to set the item. <ul style="list-style-type: none"> In this example, set "ROOM SIZE" to "5." 		
5. Set other items on the same submenu if necessary. <ol style="list-style-type: none"> Press ▾ or ▲ (DOWN or UP) repeatedly to select another item on the same submenu if necessary. Press ▶ or ◀ (RIGHT or LEFT) to set the item. <ul style="list-style-type: none"> In this example, set "LIVENESS" to "5." 		

To return to the previous screens

Press EXIT.

Each time you press the button, the on-screen display menu returns to the one previously displayed. (On the unit's main display, the indications also change accordingly.)

To erase the menu (to return to the regular screen)

Press ADJUST MENU.

* "ADJUST" appears only when using the button on the unit.
 ** When using the buttons on the unit, the last item selected will appear; on the other hand, when using the remote control, the first-listed item on the menu will always appear.

Adjusting the Speaker Channel Output Levels—LEVEL (1)

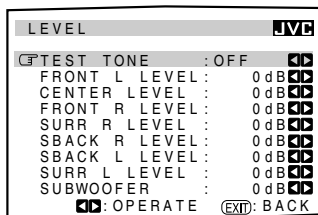

On this submenu, you can adjust the speaker channel output levels. While outputting the test tone, select a speaker channel and adjust its output level. Once adjustment is done on this submenu, it is stored for each source when you change the source or when you turn off the receiver.

Notes:

- The speaker level adjustments except the left/right front level and subwoofer level will be affected and be changed according to the Surround/DSP mode setting.
- You can show this submenu simply by pressing TEST button on the remote control. Test tone comes out of the activated speakers in sequence. (See page 49.)

Adjustment procedure on this submenu

Adjustment is also possible without outputting the test tone. In this case, you can skip steps 1, 2 and 6 below.

- 1 Press ∇ or Δ (DOWN or UP) to select “TEST TONE.”
- 2 Press \triangleright or \triangleleft (RIGHT or LEFT) to output the test tone. (See “Outputting the test tone” below.)
- 3 Press ∇ or Δ (DOWN or UP) to select a speaker you want to adjust.
- 4 Press \triangleright or \triangleleft (RIGHT or LEFT) to adjust the speaker output level.
- 5 Repeat step 3 and 4 to adjust the other speaker output levels.
- 6 After adjustment is finished, stop the test tone.
 - ① Press Δ or ∇ (UP or DOWN) to select “TEST TONE.”
 - ② Press \triangleright or \triangleleft (RIGHT or LEFT) to select “OFF.”

Outputting the test tone

CAUTION:

Test tone is automatically fixed to 0 dB, but this level will be louder than you would expect.

Select one of the following.

- Test tone will be heard about three seconds after you select “AUTO” or “MANUAL.”

AUTO : When this is selected, the test tone comes out of all the activated speakers in sequence (for 2 seconds each). The test tone comes out of the activated speakers in the following sequence:

Left front speaker → Center speaker → Right front speaker
 → Right surround speaker → Right surround back speaker
 → Left surround back speaker → Left surround speaker
 → Subwoofer → (Back to the beginning)

MANUAL : When this is selected, the test tone comes out of only the speaker you select. (To select the speaker, see the right column.)

OFF : Select this to stop the test tone.

Notes:

- “TEST TONE” is not available if both speakers 1 and 2 are deactivated or if Surround mode is turned off.
- If “NO” or “NONE” is selected for a speaker on the SPEAKER SETTING submenu (page 36), test tone does not come out of the speaker.

Adjusting the speaker channel output levels

Select and adjust the following speakers:

FRONT L LEVEL : Select this to adjust the left front speaker output level within the range of **-20 dB** to **+10 dB**, and **---** dB (no sound).

FRONT R LEVEL : Select this to adjust the right front speaker output level within the range of **-20 dB** to **+10 dB**, and **---** dB (no sound).

CENTER LEVEL : Select this to adjust the center speaker output level within the range of **-10 dB** to **+10 dB**.

SURR L LEVEL : Select this to adjust the left surround speaker output level within the range of **-10 dB** to **+10 dB**.

SURR R LEVEL : Select this to adjust the right surround speaker output level within the range of **-10 dB** to **+10 dB**.

SBACK L LEVEL : Select this to adjust the left surround back speaker output level within the range of **-10 dB** to **+10 dB**.

SBACK R LEVEL : Select this to adjust the right surround back speaker output level within the range of **-10 dB** to **+10 dB**.

SUBWOOFER : Select this to adjust the subwoofer output level within the range of **-10 dB** to **+10 dB**.

Note:

If “NO” or “NONE” is selected for a speaker on the SPEAKER SETTING submenu (page 36), you cannot adjust its output level.

Adjusting the Parametric Equalizer —PARAMETRIC EQ (2)

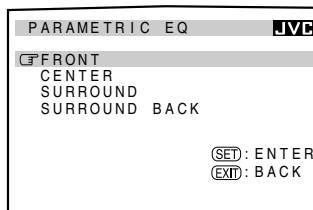

On this submenu, you can adjust equalization patterns according to your preference. First, select the signal channel (speaker) you want to adjust, then move to its adjustment screen.

Notes:

- This function is applied only to the main room sources.
- If “NO” or “NONE” is selected for a speaker on the SPEAKER SETTING submenu (see page 36), you cannot select the corresponding channel.
- If THX Surround or DVD MULTI playback mode is in use, this submenu is not available.

Continued on the next page.

■ Adjustment procedure on this submenu

- 1 Press ∇ or Δ (DOWN or UP) to select the channel—FRONT, CENTER, SURROUND, or SURROUND BACK, then press SET.
The adjustment screen of the selected item appears.
- 2 Press ∇ or Δ (DOWN or UP) to select an item you want to adjust on the selected adjustment screen.
- 3 Press \triangleright or \triangleleft (RIGHT or LEFT) to adjust the item.
 - Once one of the sound levels—“BASS LEVEL,” “MID LEVEL” and “TREBLE LEVEL”—is adjusted, the PARAMETRIC EQ indicator lights up on the display.
- 4 Repeat steps 2 and 3 to adjust the other items on the same adjustment screen.
- 5 Press EXIT once.
The PARAMETRIC EQ submenu appears again.
- 6 Repeat steps 1 to 5 to adjust the other channels.

To cancel the adjustment, set all the sound levels—“BASS LEVEL,” “MID LEVEL” and “TREBLE LEVEL”—to “0 dB.” The PARAMETRIC EQ indicator goes off.

■ Adjustment screen

On these adjustment screens, you can adjust the following items for each channel signal.

PEQ FRONT JVB BASS FREQ : 100Hz BASS LEVEL : 0dB MID FREQ : 1.0kHz MID LEVEL : 0dB TREBLE FREQ : 10.0kHz TREBLE LEVEL : 0dB	PEQ CENTER JVB BASS FREQ : 100Hz BASS LEVEL : 0dB MID FREQ : 1.0kHz MID LEVEL : 0dB TREBLE FREQ : 10.0kHz TREBLE LEVEL : 0dB
PEQ SURROUND JVB BASS FREQ : 100Hz BASS LEVEL : 0dB MID FREQ : 1.0kHz MID LEVEL : 0dB TREBLE FREQ : 10.0kHz TREBLE LEVEL : 0dB	PEQ SURR BACK JVB BASS FREQ : 100Hz BASS LEVEL : 0dB MID FREQ : 1.0kHz MID LEVEL : 0dB TREBLE FREQ : 10.0kHz TREBLE LEVEL : 0dB

BASS FREQ*	: Select the center frequency to adjust bass sounds from —63 Hz, 80 Hz, 100 Hz (initial), 125 Hz, 160 Hz, 200 Hz, 250 Hz, 320 Hz, 400 Hz, 500 Hz, 630 Hz, 800 Hz, 1.0 kHz
BASS LEVEL	: Adjust the enhancement level for bass sounds (with in the range of +6 dB to -6 dB).
MID FREQ*	: Select the center frequency to adjust middle-range sounds from —250 Hz, 320 Hz, 400 Hz, 500 Hz, 630 Hz, 800 Hz, 1.0 kHz (initial), 1.25 kHz, 1.6 kHz, 2.0 kHz, 2.5 kHz, 3.2 kHz, 4.0 kHz
MID LEVEL	: Adjust the enhancement level for middle-range sounds (with in the range of +6 dB to -6 dB).
TREBLE FREQ*	: Select the center frequency to adjust treble sounds from—1.0 kHz, 1.25 kHz, 1.6 kHz, 2.0 kHz, 2.5 kHz, 3.2 kHz, 4.0 kHz, 5.0 kHz, 6.3 kHz, 8.0 kHz, 10.0 kHz (initial), 12.5 kHz, 16.0 kHz
TREBLE LEVEL	: Adjust the enhancement level for treble sounds (with in the range of +6 dB to -6 dB).

* Adjustable range changes according to the other two frequency settings.

■ Adjusting the DSP Parameters

—DSP PARAMETER (3)

DSP PARAMETER		JVB
EFFECT LEVEL	: 3	↔
ROOM SIZE	: 3	↔
LIVENESS	: 3	↔
WALL TYPE	: 3	↔
SEAT POSITION	: 1	↔
↔ : OPERATE EXIT : BACK		

On this submenu, you can adjust DSP parameters.

- This submenu is available only when the DSP mode* is on, and the settings made apply only to the DSP mode* (*except All Channel Stereo).

Note:

When the front speakers are deactivated, you cannot adjust the DSP parameters.

■ Adjusting the DSP parameters

Select and adjust the following parameters:

EFFECT LEVEL: Adjust the DSP effect level.

As the number increases, the DSP effect becomes stronger. (Normally select “3.” Adjustable range: **1** to **5**)

ROOM SIZE: Adjust the virtual room size. As the number increases, the interval between reflections increases so that you will feel as if you were in a larger room. (Normally select “3.” Adjustable range: **1** to **5**)

LIVENESS: Adjust the liveness effect. As the number increases, the attenuation level of reflections over time decreases so that acoustics change from “Dead” to “Live.” (Normally select “3.” Adjustable range: **1** to **5**)

WALL TYPE: Adjust the wall type. As the number increases, the hardness of the wall to be simulated seems to become “soft” to “hard.” (Normally select “3.” Adjustable range: **1** to **5**)

SEAT POSITION: Select this to either **1** or **2** according to your preference as if you change your seat in a theater, hall, recital hall, church, etc.

■ Adjusting the Center Channel

—CENTER CHANNEL (4)

CENTER CHANNEL		JVB
CENTER EQ	: OFF	↔
CENTER ALIGNMENT	: OFF	↔
↔ : OPERATE EXIT : BACK		

On this submenu, you can set center channel signal adjustment for the DSP modes.

- This submenu is available only when the DSP mode* is on, and the settings made apply only to the DSP mode* (*except All Channel Stereo).

■ Cutting off the high frequency range in the center channel

Cut off the high frequency range signals in the center channel.

ON : Select this to cut off the high frequency range signals.

OFF : Select this not to cut off the high frequency range signals.

■ Setting the center channel alignment

Align the vertical localization of the center channel signals (mainly human voices are recorded) at the same height as for the front speakers.

ON : Select this when you cannot feel the actors or singers are not speaking or singing on the screen.

OFF : Center channel alignment is turned off.

Using the Surround Modes

This unit activates a variety of Surround Modes automatically according to the stored basic settings and adjustments performed on the Setup and Adjustment Menus (see pages 33 to 45).

- The following operations are only possible when the receiver is ready for the main room operations, and are used only for the main room sources.

Reproducing Theater Ambience

In a movie theater, many speakers are located on the walls to reproduce impressive multi-surround sounds, reaching you from all directions.

With these many speakers, sound localization and sound movement can be expressed.

Surround modes built in this receiver can create almost the same surround sounds as you can feel in a real movie theater—with only five or seven speakers (plus subwoofer).

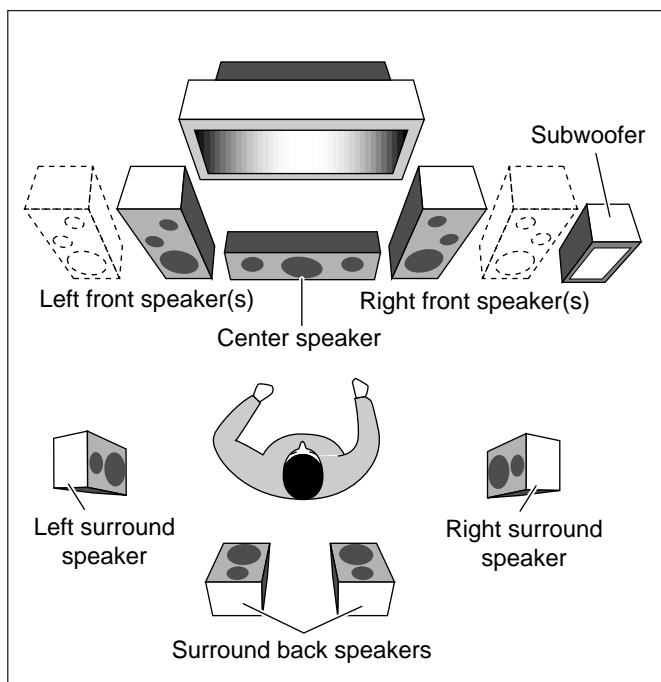
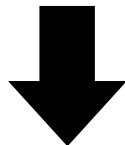
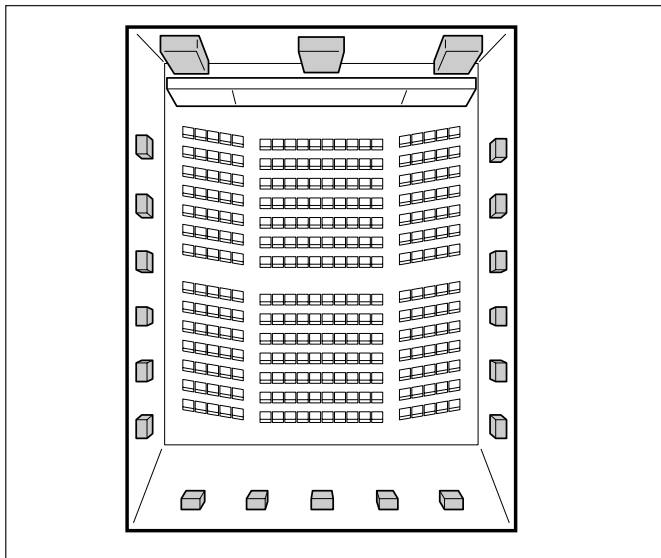

Introducing the Surround Modes

THX Surround EX (Dolby Digital EX)*

Best used to reproduce multichannel sound tracks of the software encoded with Dolby Digital EX.

- To enjoy the software encoded with Dolby Digital EX, connect the source component using the digital terminal on the rear of this receiver. (See page 14.)

Dolby Digital EX is a new digital surround encoding format that adds the third surround channels, called “surround back” (2 channels—but, the same signals are recorded for both left and right surround back channels).

Comparing to the conventional Dolby Digital 5.1CH, these newly added surround back channels can reproduce more detailed movements behind you while viewing the video software. In addition, surround sound localization will become more stable. The **THX Surround EX*** mode built in this receiver decodes Dolby Surround EX encoding, and allows you to enjoy a realistic surround field in your listening room.

Furthermore, this decoder also works for any sound source, applying one of two THX Surround modes—“THX SURR EX” or “THX CINEMA.”

- “THX SURR EX” or “THX CINEMA” is automatically selected when you press THX ON/OFF.

THX SURR EX: To reproduce the sound through all activated speakers. (Best for playing Dolby Digital EX or DTS-ES encoded software)

THX CINEMA: To reproduce the sound through all activated speakers except the surround back speakers.

Dolby Digital 5.1CH**

Used to reproduce multichannel sound tracks of the software encoded with Dolby Digital ().

- To enjoy the software encoded with Dolby Digital, connect the source component using the digital terminal on the rear of this receiver. (See page 14.)

Dolby Digital 5.1CH encoding method (so-called discrete 5.1 channel digital audio format) records and digitally compresses the left front channel, right front channel, center channel, left surround channel, right surround channel, and LFE channel signals (total 6 channels, but LFE channel is counted as 0.1 channel. Therefore, called 5.1 channel).

As each channel is completely independent from the other channel signals to avoid interference, you can obtain a much better sound quality with better stereo and surround effects.

In addition, Dolby Digital enables stereo surround sounds, and sets the cutoff frequency of the surround treble at 20 kHz, compared to 7 kHz for Dolby Pro Logic. As such, the sound movement and “being-there” feeling are enhanced much more than Dolby Pro Logic.

Dolby Surround (Dolby Pro Logic)**

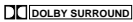
Used to reproduce sound tracks of the software encoded with Dolby Surround ().

Dolby Surround encoding format records the left front channel, right front channel, center channel, and surround channel signals (total 4 channels) into 2 channels.

The **Dolby Pro Logic** decoder built in this receiver decodes these 2 channel signals into 4 original channel signals—matrix-based multichannel reproduction, and allows you to enjoy a realistic surround sound in your listening room.

- When Dolby Pro Logic is activated, the PRO LOGIC indicator lights up on the display.
- Dolby Pro Logic will be activated for all 2 channel software when the Surround mode is turned on. (The PRO LOGIC indicator lights up.)

DTS Digital Surround***

Used to reproduce multichannel sound tracks of the software encoded with DTS Digital Surround ().

- To enjoy the software encoded with DTS Digital Surround, connect the source component using the digital terminal on the rear of this receiver. (See page 14.)

DTS Digital Surround is another discrete 5.1 channel digital audio format available on CD, LD, and DVD software.

Compared to Dolby Digital, the DTS Digital Surround format has a lower audio compression rate which enables it to add breadth and depth to the sounds reproduced. As such, DTS Digital Surround features natural, solid and clear sound.

DTS Extended Surround (DTS-ES)***

This is another new digital surround encoding format that adds the third surround channels.

- This unit is compatible with DTS Extended Surround (DTS-ES). You can play back DTS-ES encoded software using THX Surround EX.

Notes:

- When the SUB ROOM speaker indicator is lit on the display, you cannot use the THX or Surround mode.
 - You can only use DAP modes (see page 50) for the main room source (the DSP and 3D-PHONIC indicators light up on the display).
- When you select “DVD MULTI” as the source to play, you cannot select the Surround and DSP modes.

3D HEADPHONE Mode

You can also enjoy the surround effect (except THX Surround modes) through the headphones.

By pressing SURROUND ON/OFF when the headphones are connected, 3D HEADPHONE mode is activated without respect to the type of software played back.

The DSP and HEADPHONE indicators also light up.

- Dolby Pro Logic will be activated for all 2-channel software. (The PRO LOGIC indicator lights up.)

DVD MULTI Playback Mode

This receiver provides the DVD MULTI playback mode for reproducing the analog discrete 5.1 channel output mode of the DVD player or other equipment.

You can adjust the DVD MULTI playback mode while playing back a video software such as a DVD using the analog discrete 5.1 channel output mode.

- For the DVD MULTI playback mode connection, see page 13.
- For details on the DVD MULTI playback mode, see page 53.

Surround modes available for input signals

Input Signals	THX ON / SURROUND ON	THX OFF / SURROUND ON	THX OFF / SURROUND OFF
Analog (2 CH)	THX CINEMA	PRO LOGIC	SURROUND OFF
Linear PCM	THX CINEMA	PRO LOGIC	SURROUND OFF
Dolby Digital	THX SURR EX or THX CINEMA* ¹	DOLBY DIGITAL or PRO LOGIC* ²	SURROUND OFF
DTS	THX SURR EX or THX CINEMA* ¹	DTS SURROUND or PRO LOGIC* ³	SURROUND OFF

*¹ Depending on the “THX” setting (see page 38).

*² When 2-channel signal comes in, DOLBY PRO LOGIC will be selected. When other signals come in, DOLBY DIGITAL will be selected.

*³ When 2-channel signal comes in, DOLBY PRO LOGIC will be selected. When other signals come in, DTS SURROUND will be selected.

* Lucasfilm and THX are registered trademarks of Lucasfilm Ltd.

** Manufactured under license from Dolby Laboratories. “Dolby,” “Pro Logic,” and the double-D symbol are trademarks of Dolby Laboratories. Confidential Unpublished Works. ©1992–1997 Dolby Laboratories, Inc. All rights reserved.

*** Manufactured under license from Digital Theater Systems, Inc. US Pat. No. 5,451,942, 5,956,674, 5,974,380, 5,978,762 and other world-wide patents issued and pending. “DTS,” “ES” and “DTS Digital Surround” are trademarks of Digital Theater Systems, Inc. Copyright 1996, 2000 Digital Theater Systems, Inc. All Rights Reserved.

Activating the Surround Modes

Perform the basic settings and adjustments using the Setup and Adjustment Menus first (see pages 33 to 45).

Activating the THX Surround and conventional Surround mode for a source automatically recalls the memorized settings and adjustments done on the above menus.

IMPORTANT:

Check to see if the following before or while using the buttons and controls.

For the main room operations:

The MAIN ROOM ON/OFF lamp on the unit is lit.

• When using the unit:

- “SUB ROOM” is not shown in the main display.
- Press DOOR DOWN to use the buttons inside the front door.
- To close the front door, press DOOR UP.



• When using the remote control:

- Set the MAIN ROOM/SUB ROOM (LEARN/TRANSMIT) selector to “MAIN ROOM.”
- Check the indication shown on the remote’s display when you press a button—this indicates the remote control operation mode together with multi-room operation mode (either MAIN ROOM or SUB ROOM) for a while (10 or 5 seconds).

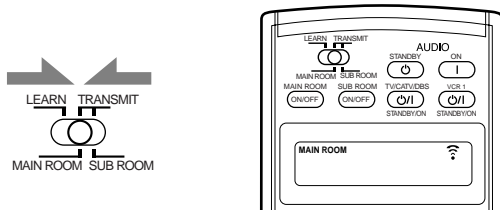

Ex. When you press THX ON/OFF with MAIN ROOM/SUB ROOM (LEARN/TRANSMIT) selector set to “MAIN ROOM.”

Before you start, remember...

When the SUB ROOM speaker indicator is lit on the display, the THX ON/OFF and SURROUND ON/OFF button do not work.

Activating the THX Surround —THX Surround EX/THX Cinema

1. Select and play any sound source.
2. Press THX ON/OFF to activate either “THX SURR EX” or “THX CINEMA.”

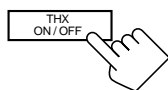

On the unit
(inside the front door)



On the remote control

THX indicator lights up.

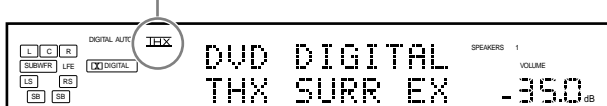

Ex. When “THX SURR EX” (THX Surround EX) is selected.

Notes:

- THX Surround EX or THX Cinema is automatically selected according to the THX submenu setting (see page 38) and to the type of the incoming signals (see page 47).
- Each time you press the button, the THX Surround turns on and off alternately. Conventional surround mode also turns on when the THX Surround is turned on.
- Dolby Pro Logic will be activated for 2-channel software—either digital or analog. (The PRO LOGIC indicator lights up.)

To cancel the THX Surround

Press THX ON/OFF again.

THX Surround is canceled and an appropriate conventional Surround mode—Dolby Digital, DTS Surround, or Dolby Pro Logic—will be selected automatically.

To cancel the conventional Surround mode, press SURROUND ON/OFF.

Activating the Conventional Surround Mode —Dolby Digital/DTS Digital Surround/Dolby Pro Logic

For conventional Surround modes, Parametric Equalizer adjustments done on the PARAMETRIC EQ submenu also take effect for the activated speaker channels. (See page 44.)

1. Select and play one of the following sound sources.

- Digital software encoded with 5.1 channel signals —Dolby Digital or DTS Surround.
- Analog software encoded with Dolby Surround.

2. Press SURROUND ON/OFF to activate the conventional Surround mode.



On the unit
(inside the front door)



On the remote control

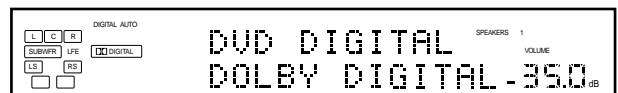

Ex. When “DOLBY DIGITAL” is selected.

An appropriate Surround mode—DOLBY DIGITAL, DTS SURROUND, or PRO LOGIC—is activated.

Notes:

- Each time you press the button, the Surround mode turns on and off alternately.
- While listening with the headphones, “3D HEADPHONE” will appear. (The DSP and HEADPHONE indicators will light up.)
- Dolby Pro Logic will be activated for 2-channel software—either digital or analog. (The PRO LOGIC indicator lights up.)

To cancel the conventional Surround mode

Press SURROUND ON/OFF again.

Adjusting the Surround Sounds Temporarily

Activating the THX Surround and conventional Surround mode for a source automatically recalls the memorized settings and adjustments done on the Setup and Adjustment Menus.

However, if you want to modify the stored adjustments temporarily only for the current playback source, you can use the TEST button and the number buttons on the remote control.

IMPORTANT:

Check to see if the following before or while using the buttons and controls.

For the main room operations:

The MAIN ROOM ON/OFF lamp on the unit is lit.

• When using the remote control:

- Set the MAIN ROOM/SUB ROOM (LEARN/TRANSMIT) selector to “MAIN ROOM.”
- Check the indication shown on the remote’s display when you press a button—this indicates the remote control operation mode together with multi-room operation mode (either MAIN ROOM or SUB ROOM) for a while (10 or 5 seconds).

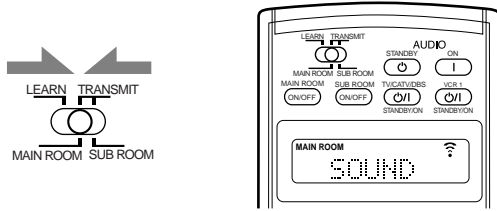

Ex. When you press SOUND with MAIN ROOM/SUB ROOM (LEARN/TRANSMIT) selector set to “MAIN ROOM.”

Before you start, remember...

- Adjustments using the number buttons are temporary and cannot be stored.
When you change the source or turn off the power, the adjustments are erased.
- Make sure that you have set the speaker information correctly (see page 36). You cannot select and adjust the output level of the speaker if the speaker is not activated (set to “NONE” or “NO”) on the SPEAKER SETTING submenu.

CAUTION:

Test tone is automatically fixed to 0 dB, but this level will be louder than you would expect.

1. Press SOUND.

The 10 keys are activated for sound adjustments.

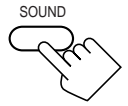

2. Press TEST once to check the speaker output balance.

The test tone comes out of all the activated speakers in the following sequence:

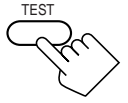

Left front speaker → Center speaker → Right front speaker
→ Right surround speaker → Right surround back speaker
→ Left surround back speaker → Left surround speaker
→ Subwoofer → (Back to the beginning)

Notes:

- The LEVEL submenu (see page 44) appears on the TV screen.
- If “NO” or “NONE” is selected for a speaker on the SPEAKER SETTING submenu (page 36), test tone does not come out of that speaker, and adjustments in the following steps cannot be made.

3. Select the speaker you want to adjust.

The selected speaker name appears on the remote’s display for a while.

- To select the left front speaker, press FRONT•L.
- To select the center speaker, press CENTER.
- To select the right front speaker, press FRONT•R.
- To select the right surround speaker, press SURR•R.
- To select the right surround back speaker, press SURR BK•R.
- To select the left surround back speaker, press SURR BK•L.
- To select the left surround speaker, press SURR•L.
- To select the subwoofer, press SUBWFR.



4. Press LEVEL +/- to adjust the speaker output levels.

The speaker name selected in the above step and its level appear on the unit’s display.

- You can adjust the levels as follows:
 - Left and right front speakers : –20 dB to +20 dB
 - Other speakers : –10 dB to +10 dB

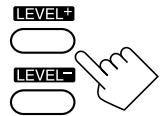

5. Repeat steps 3 and 4 to adjust the other speaker output levels.

6. Press TEST again to stop the test tone.

Using the DSP Modes

This unit provides a variety of DSP (Digital Signal Processor) Modes.

- The following operations are only possible when the receiver is ready for the main room operations, and are used only for the main room sources.

Reproducing the Sound Field

The sound heard in a concert hall, club, etc. consists of direct sound and indirect sound—early reflections and reflections from behind. Direct sounds reach the listener directly without any reflection. On the other hand, indirect sounds are delayed by the distances of the ceiling and walls. These direct sounds and indirect sounds are the most important elements of the acoustic surround effects. The Surround and DSP modes can create these important elements, and give you a real “being there” feeling.

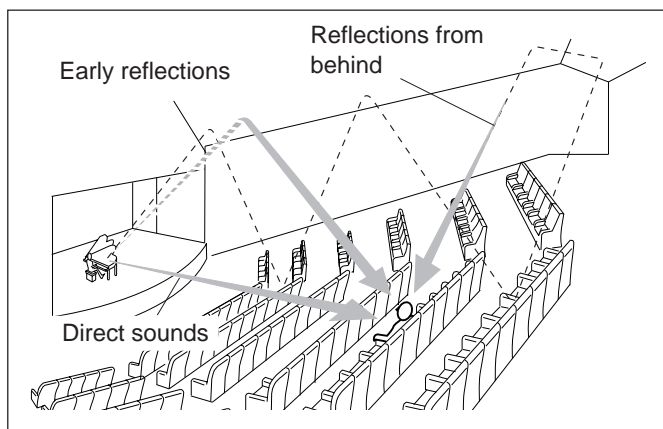

Introducing the DSP Modes

The DSP modes include the following modes—

- DAP (Digital Acoustic Processor) modes (LARGE HALL 1, LARGE HALL 2, RECITAL HALL, OPERA HOUSE, CHURCH, LIVE CLUB, DANCE CLUB, PAVILION, LARGE THEATER, SMALL THEATER)
- ALL CH STEREO
- STEREO FILM/MONO FILM
- 3D THEATER

The following settings you have done are memorized and valid for the DSP modes:

- LEVEL submenu (see page 44)
—Valid only for activated speakers.
- PARAMETRIC EQ submenu (see page 44)
—Valid only for activated speakers.
- DSP PARAMETER submenu (see page 45)
—Valid except for All Channel Stereo.
- CENTER CHANNEL submenu (See page 45)
—Valid only for the center speaker channel when the center speaker is activated. (Not valid for All Channel Stereo.)

To use the DSP modes, press DSP MODE so that the DSP modes change as follows.

→ LARGE HALL 1 → LARGE HALL 2 → RECITAL HALL
 → OPERA HOUSE → CHURCH → LIVE CLUB
 → DANCE CLUB → PAVILION → ALL CH STEREO
 → LARGE THEATER → SMALL THEATER
 → STEREO FILM → MONO FILM → 3D THEATER
 → SURROUND OFF (DSP off) → (Back to the beginning)

■ : Suitable for audio sources
 □ : Suitable for video sources

DAP modes

You can use the following DAP modes in order to reproduce a more acoustic sound field in your listening room.

-
- LARGE HALL 1** : Reproduces the spatial feeling of a large shoebox-shaped hall designated primarily for classical concerts. (Its seating capacity is about 2000.)
-
- LARGE HALL 2** : Reproduces the spatial feeling of a large vineyard-shaped hall designated primarily for classical concerts. (Its seating capacity is about 2000.)
-
- RECITAL HALL** : Reproduces the spatial feeling of a small hall designated primarily for classical recitals. (Seating capacity is about 500.)
-
- OPERA HOUSE** : Reproduces the spatial feeling of an opera house with a high ceiling and multi-level seating layout.
-
- CHURCH** : Reproduces the spatial feeling of a majestic church with a high ceiling.
-
- LIVE CLUB** : Reproduces the spatial feeling of a live music club with a low ceiling.
-
- DANCE CLUB** : Reproduces the spatial feeling of a rocking dance club.
-
- PAVILION** : Reproduces the spatial feeling of an exhibition hall with a high ceiling.
-
- LARGE THEATER** : Reproduces the spatial feeling of a large theater where the seating capacity is about 600. The built-in Dolby Pro Logic decoder is activated. (The PRO LOGIC indicator lights up.)
-
- SMALL THEATER** : Reproduces the spatial feeling of a small theater where the seating capacity is about 300. The built-in Dolby Pro Logic decoder is activated. (The PRO LOGIC indicator lights up.)
-

When using the DAP mode, the sounds come out of all the connected and activated speakers.

- If only front speakers are connected, JVC’s original 3D-PHONIC processing (which has been developed to create the surround effect only through the front speakers) is used. The 3D-PHONIC indicator lights up on the display.

ALL Channel Stereo mode (ALL CH STEREO)

This mode can reproduce a larger stereo sound field using all the connected (and activated) speakers. **This mode cannot be used without connecting the surround speakers.**

- The CENTER CHANNEL submenu settings and the DSP PARAMETER submenu settings cannot be applied to All Channel Stereo mode. (You cannot adjust them for this mode.)
- **If headphones are connected or if the front speakers are deactivated, "ALL CH STEREO" cannot be selected.** (See "HEADPHONE Mode" below.)

Stereo Film and Monaural Film modes

In order to reproduce a more acoustic sound field in your listening room while viewing stereo sound or monaural sound video software (analog and 2-channel digital signals), you can use these modes. The surround effect will be added, and the sound localization of actor's words will be improved.

- STEREO FILM** : To play back stereo video software
- MONO FILM** : To play back monaural video software

When "STEREO FILM" or "MONO FILM" is used, sounds come out of all the connected (and activated) speakers.

3D THEATER

Only using the front speaker, this mode gives you such a true and clear surround effect as is reproduced through the Dolby Surround decoder, which is widely used to reproduce sounds with a feeling of movement like those experienced in movie theaters.

- When "3D THEATER" is used, the DSP and 3D-PHONIC indicators light up. The PRO LOGIC indicator also lights up when 2-channel software is played back. (Dolby Pro Logic decoder is activated.)
- **If the center speaker is connected (and activated):** Sounds created by the built-in DSP (Digital Signal Processor) come out of the center speaker to localize the sounds. So, you can feel as if actors on the screen actually speak in your room.
- **If headphones are connected, "3D HEADPHONE" will be activated.** (See "3D HEADPHONE Mode" on page 47.)

HEADPHONE Mode

You can also enjoy the DSP effect (except All Channel Stereo mode) through the headphones.

By pressing DSP MODE when the headphones are connected, HEADPHONE mode is activated without respect to the type of software played back. The DSP and HEADPHONE indicators also light up.

Activating the DSP Modes

Perform the basic settings and adjustments using the Setup and Adjustment Menus first (see pages 33 to 45).

Activating one of the DSP modes for a source automatically recalls the memorized settings and adjustments done on the above menus.

IMPORTANT:

Check to see if the following before or while using the buttons and controls.

For the main room operations:

The MAIN ROOM ON/OFF lamp on the unit is lit.

- **When using the unit:**
 - "SUB ROOM" is not shown in the main display.
 - Press DOOR DOWN to use the buttons inside the front door. To close the front door, press DOOR UP.
- **When using the remote control:**
 - Set the MAIN ROOM/SUB ROOM (LEARN/TRANSMIT) selector to "MAIN ROOM."
 - Check the indication shown on the remote's display when you press a button—this indicates the remote control operation mode together with multi-room operation mode (either MAIN ROOM or SUB ROOM) for a while (10 or 5 seconds).

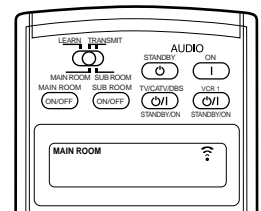
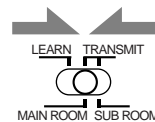

Ex. When you press DSP MODE with MAIN ROOM/SUB ROOM (LEARN/TRANSMIT) selector set to "MAIN ROOM."

Before you start, remember...

When the SUB ROOM speaker indicator is lit on the display, you can select only the DAP modes (with the 3D-PHONIC decoder activated.)

1. Select and play any sound source.
2. Press DSP MODE repeatedly until the DSP mode you want appears on the display.

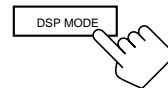

On the unit (inside the front door)

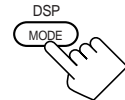

On the remote control

The DSP indicator also lights up on the display.

- Each time you press the button, the DSP modes change as follows:

- LARGE HALL 1 → LARGE HALL 2 → RECITAL HALL
- OPERA HOUSE → CHURCH → LIVE CLUB
- DANCE CLUB → PAVILION → ALL CH STEREO
- LARGE THEATER → SMALL THEATER
- STEREO FILM* → MONO FILM* → 3D THEATER
- SURROUND OFF (DSP off) → (Back to the beginning)

* When multichannel signals come in, you cannot select "STEREO FILM" and "MONO FILM."

Notes:

- When the surround speakers are deactivated, the 3D-PHONIC processing is applied to the DSP modes (the 3D-PHONIC indicator also lights up).
- If "USER MODE 1" (then "NO DATA") appears, press and hold DSP MODE on the unit until it disappears. (This mode is only for service personnel.)

To cancel the DSP modes

Press DSP MODE repeatedly until "SURROUND OFF" appears on the display.

- When a pair of headphones is connected or when the front speakers are deactivated, "HEADPHONE" will appear.

If you want to modify the stored sound adjustments temporarily

See "Adjusting Surround Sounds Temporarily" on page 49.

- When adjusting the surround sounds for the DSP modes, you cannot output the test tone.
- When you select "3D THEATER," you cannot adjust the surround speaker levels and surround back speaker levels.

Adjusting the DSP Parameters Temporarily

Activating the DSP mode for a source automatically recalls the memorized DSP parameter settings done on the Adjustment Menu.

However, if you want to modify the stored adjustments temporarily only for the current playback source, you can use the number buttons on the remote control.

IMPORTANT:

Check to see if the following before or while using the buttons and controls.

For the main room operations:

The MAIN ROOM ON/OFF lamp on the unit is lit.

- **When using the remote control:**
 - Set the MAIN ROOM/SUB ROOM (LEARN/TRANSMIT) selector to "MAIN ROOM."
 - Check the indication shown on the remote's display when you press a button—this indicates the remote control operation mode together with multi-room operation mode (either MAIN ROOM or SUB ROOM) for a while (10 or 5 seconds).

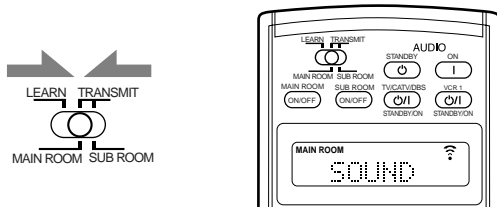

Ex. When you press SOUND with MAIN ROOM/SUB ROOM (LEARN/TRANSMIT) selector set to "MAIN ROOM."

Before you start, remember...

- Adjustments using the number buttons are temporary and cannot be stored.
- When you change the source or turn off the power, the adjustments are erased.
- When you select "ALL CH STEREO," you cannot adjust the DSP parameters.

1. Press SOUND.

The 10 keys are activated for sound adjustments.

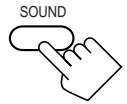

2. Press EFFECT to adjust the overall level of the effect.

- Each time you press the button, the effect level changes as follows:

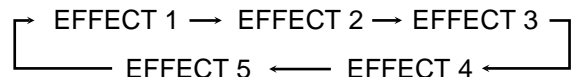

As the number increases, the selected DSP effect becomes stronger. (Normally set it to "EFFECT 3.")

3. Press ROOM SIZE to adjust the room size (sense of spaciousness).

- Each time you press the button, the display changes to show the following:

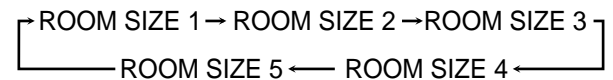

As the number increases, the interval between reflections increases so that you will feel as if you were in a larger room. (Normally set it to "ROOM SIZE 3.")

4. Press LIVENESS to adjust the liveness.

- Each time you press the button, the display changes to show the following:

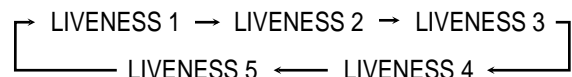

As the number increases, the attenuation level of reflections over time decreases so that acoustics change from "Dead" to "Live." (Normally set it to "LIVENESS 3.")

5. Press WALL to adjust the wall type.

- Each time you press the button, the display changes to show the following:

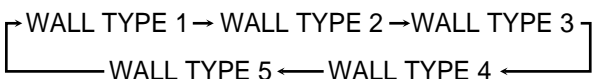
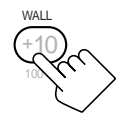

As the number increases, the hardness of the wall to be simulated changes from "Soft" to "Hard." (Normally set it to "WALL TYPE 3.")

Notes:

- You cannot adjust "SEAT POSITION" using the number buttons. If you want to adjust it, see page 45.
- When the front speakers are deactivated, you cannot adjust the DSP parameters.

Using the DVD MULTI Playback Mode

This receiver provides the DVD MULTI playback mode for reproducing the analog discrete output mode of the DVD player. Before playing back a DVD, refer also to the manual supplied for the DVD player.

- The following operations are only possible when the receiver is ready for the main room operations, and are used only for the main room source—DVD MULTI.

Activating the DVD MULTI Playback Mode

Perform the basic settings and adjustments using the Setup and Adjustment Menus first (see pages 33 to 45).

Activating DVD MULTI playback mode automatically recalls the memorized settings and adjustments done on the above menus.

- You also need to set the DVD player to the analog discrete output mode.

IMPORTANT:

Check to see if the following before or while using the buttons and controls.

For the main room operations:

The MAIN ROOM ON/OFF lamp on the unit is lit.

• When using the unit:

- “SUB ROOM” is not shown in the main display.
- Press DOOR DOWN to use the buttons inside the front door.
- To close the front door, press DOOR UP.



• When using the remote control:

- Set the MAIN ROOM/SUB ROOM (LEARN/TRANSMIT) selector to “MAIN ROOM.”
- Check the indication shown on the remote's display when you press a button on the remote control—this indicates the remote control operation mode together with multi-room operation mode (either MAIN ROOM or SUB ROOM) for a while (10 or 5 seconds.)

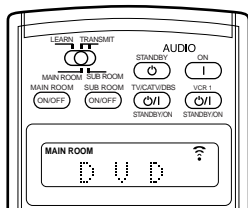
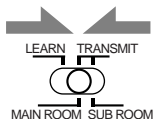

Ex. When you press DVD MULTI with MAIN ROOM/SUB ROOM (LEARN/TRANSMIT) selector set to “MAIN ROOM.”

Before you start, remember...

- Make sure that you have connected the DVD player to the analog discrete input (5.1 CH reproduction) jacks on the rear (see page 13).
- When the SUB ROOM speaker indicator is lit on the display, the DVD MULTI button does not work.

1. Press DVD MULTI so that “DVD MULTI” appears on the display.



On the unit
(inside the front door)



On the remote control

Note:

When you select “DVD MULTI” as the main room source to play, the THX ON/OFF, SURROUND ON/OFF and DSP MODE buttons do not work.

2. Select the analog discrete output mode on the DVD player, and start playing a DVD.

- Refer to the manual supplied with the DVD player.

If you want to modify the stored sound adjustments temporarily

See “Adjusting Surround Sounds Temporarily” on page 49.

- When adjusting the sounds for the DVD MULTI playback mode, you cannot output the test tone.
- If “L/R” is selected on the SURROUND SPEAKERS submenu (see page 38), you cannot adjust the output levels of the surround back speakers.

COMPU LINK Remote Control System

The COMPU LINK remote control system allows you to operate JVC audio components through this receiver.

To use this remote control system, you need to connect JVC audio components through the COMPU LINK (SYNCHRO) jacks (see below) in addition to the connections using cables with RCA pin plugs (see pages 9 and 10).

- Make sure that the AC power cords of these components are unplugged before connection. Plug the AC power cords only after all connections are complete.

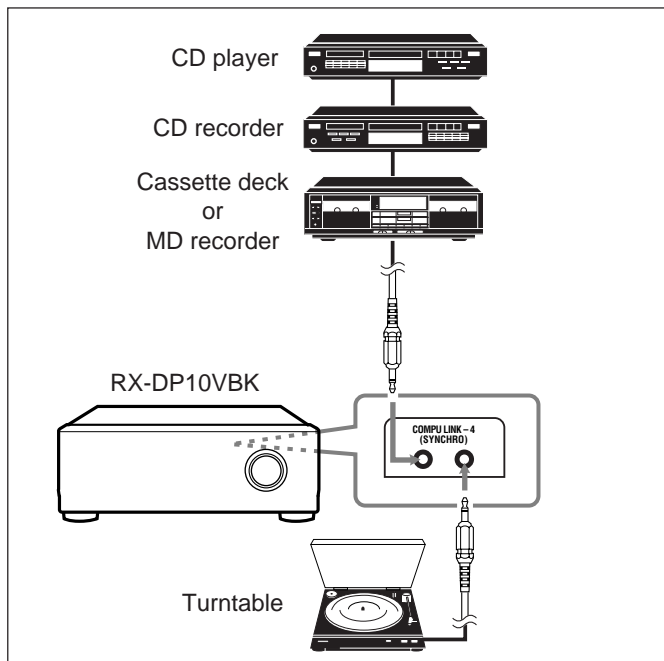

Notes:

- There are four versions of COMPU LINK remote control system. This receiver is equipped with the fourth version—COMPU LINK-4. This version is created by adding systematic operations with the CD recorder to the previous version—COMPU LINK-3.
- If your audio component has two COMPU LINK jacks, you can use either one. If it has only one COMPU LINK jack, connect it so that it is the last item in the series of components. (For example, the turntable or CD player on the left column.)
- To operate the cassette deck or MD recorder using the COMPU LINK remote control system, set the source name correctly. (See page 25.)
- Refer also to the manuals supplied for your audio components.

This remote control system allows you to use four functions listed below.

Remote Control through the Remote Sensor on the Receiver

You can control the connected audio components through the receiver using this remote control. For details, see pages 64 and 65.

Automatic Source Selection

- When you press the play (▶) button on a connected component or on its own remote control, the receiver automatically turns on and changes the **main room source** to the component.



- If the receiver is already turned on with the SUB ROOM ON/OFF lamp on the unit lit, and source name for the sub-room appears on the display, the receiver changes the **sub-room source** to the component.



IMPORTANT:

Check to see if the following before or while using the buttons and controls.

For the main room operations:

The MAIN ROOM ON/OFF lamp on the unit is lit.

For the sub-room operations:

The SUB ROOM ON/OFF lamp on the unit is lit.

When using the unit:

- For the main room operations: “SUB ROOM” is not shown in main display.
- For the sub-room operations: “SUB ROOM” is shown in the main display.
- Press DOOR DOWN to use the buttons inside the front door. To close the front door, press DOOR UP.



When using the remote control:

When operating the receiver using the remote control, the display on the unit always shows the main room source information though you are operating it for the sub-room source.

- Set the MAIN ROOM/SUB ROOM (LEARN/TRANSMIT) selector to “MAIN ROOM” or “SUB ROOM” correctly.
- Check the indication shown on the remote's display when you press a button—this indicates the remote control operation mode together with multi-room operation mode (either MAIN ROOM or SUB ROOM) for a while (10 or 5 seconds).

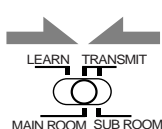
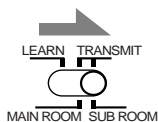

- When you press PLAY on the remote control supplied for this receiver, the receiver automatically turns on and changes the **main room source** or **sub-room source** to the target component, depending on MAIN ROOM/SUB ROOM (LEARN/TRANSMIT) selector setting on the remote control.



- When you select a new source on the receiver or on the remote control supplied for this receiver either for **the main room** or **sub-room**, the newly selected component begins playing immediately, and the previously selected source continues playing without sound for a few seconds.

Note:

If the source changes from an analog source, for which Line Direct (see page 25) is activated, to a digital source, muting time* will be a little longer.

* The period during which the receiver changes the source mechanically. No sound comes out during this period.

Automatic Power On/Off (Standby): only possible with the COMPU LINK-3 and COMPU LINK-4 connection

Automatic Power On:

- When you turn on the receiver by pressing **⏻/| (STANDBY/ON)** on the unit, or **AUDIO | (ON)** on the remote control with **MAIN ROOM/SUB ROOM (LEARN/TRANSMIT)** selector set to “MAIN ROOM”:

OR

When you turn on the main room sound by pressing MAIN ROOM ON/OFF while the receiver is turned on:

- ➔ The MAIN ROOM ON/OFF lamp lights up, and the source name for the main room appears on the display, and one of the connected components will turn on automatically, depending on which component has been previously selected as the **main room source**.

- When you turn on the receiver by pressing **AUDIO | (ON)** on the remote control, with **MAIN ROOM/SUB ROOM (LEARN/TRANSMIT)** selector set to “SUB ROOM”:

OR

When you turn on the sub-room sound by pressing SUB ROOM ON/OFF while the receiver is turned on:

- ➔ The SUB ROOM ON/OFF lamp lights up and one of the connected components will turn on automatically, depending on which component has been previously selected as the **sub-room source**.

Automatic Power Off (Standby):

- When you turn off the receiver by pressing **⏻/| (STANDBY/ON)** on the unit, or **AUDIO ⏻ (STANDBY)** on the remote control, the connected components will turn off (standby).
- When you turn off the main room sound by pressing **MAIN ROOM ON/OFF**, the selected **main room source** component turns off (unless the same component is selected as the sub-room source).
 - If the SUB ROOM ON/OFF lamp is lit, the **main room source** will stop playing, but will not turn off.
- When you turn off the sub-room source by pressing **SUB ROOM ON/OFF**, the selected **sub-room source** component turns off (unless the same component is selected as the main room source).
 - If the MAIN ROOM ON/OFF lamp is lit, the **sub-room source** will stop playing, but will not turn off.

Synchronized Recording

This operation is only possible when the receiver is ready for the main room operations.

Synchronized recording means the cassette deck (or MD recorder) starts recording as soon as a CD begins playing.

- When using a CD player for synchronized recording, refer to the manual supplied with it.

To use synchronized recording, follow these steps:

1. **Put a tape in the cassette deck (or an MD in the MD recorder), and a disc in the CD player.**
2. **Press the record (●) button and the pause (⏸) button on the cassette deck (or MD recorder) at the same time.**

This puts the cassette deck (or MD recorder) into recording pause.

If you do not press the record (●) button and pause (⏸) button at the same time, the synchronized recording feature will not operate.

3. **Press the play (▶) button on the CD player.**

The **main room source** changes on the receiver, and as soon as play starts, the cassette deck (or MD recorder) starts recording. When play ends, the cassette deck (or MD recorder) enters recording pause, and stops about 4 seconds later.

Notes:

- During synchronized recording;
 - the selected main room source cannot be changed. (You can change the sub-room source.)
 - If the same source is selected both for the main room and the sub-room, operating the sub-room source will affect the recording.
- The COMPU LINK remote control system may not operate properly during synchronized recording;
 - If the power of any component is shut off.
 - If the main room sound is turned off by pressing MAIN ROOM ON/OFF.
 - In this case, you must start again from the beginning.

TEXT COMPU LINK Remote Control System

The TEXT COMPU LINK remote control system has been developed to deal with the disc information recorded in the CD Text* and MDs. Using this information in the discs, you can operate the CD player or MD recorder with the TEXT COMPU LINK remote control system through the receiver.

CONNECTIONS:

To use this remote control system, you need to connect the CD player and/or MD recorder you want to operate, following the procedures below.

1. If you have already plugged your CD player, MD recorder, and this receiver into the AC outlets, unplug their AC power cords first.
2. Connect your CD player, MD recorder, and this receiver as follows, through the COMPU LINK jacks and TEXT COMPU LINK jacks.

- 1) **COMPU LINK jacks:** Use the cables with the monaural mini-plugs (not supplied with this receiver).

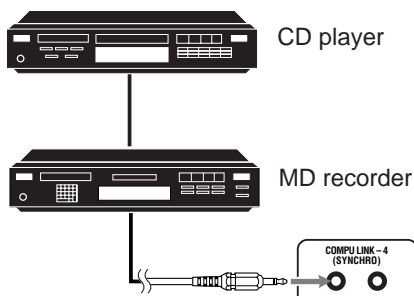

- 2) **TEXT COMPU LINK jacks:** Use the cables with the stereo mini-plugs (not supplied with this receiver).

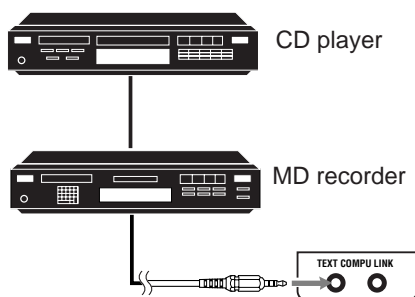

3. Connect your CD player, MD recorder and this receiver, using the cables with RCA pin plugs (see page 10).
4. Plug the AC power cords of these components above into the AC outlets.
5. When turning on these components for the first time, turn on the connected components first, then turn on this receiver.

FUNCTIONS:

This remote control system allows you to use the functions listed below.

Displaying the Disc Information on the TV screen

Disc information such as its performer and disc title (and track titles only when a CD Text is selected) is shown on the TV screen.

Disc Search: Only for CD Player

This remote control system allows you to search for discs by the performer, disc title, and music genre. With this disc search, you can easily find the disc you want to play.

Disc Title Input:

If your CD player or MD recorder has the disc memory function, you can input the following information about the normal audio CDs or MDs on the TV screen.

- For CDs: Performer, disc title, and music genre
- For MDs: Disc title and song titles

*What is a CD Text?

In a CD Text, some information about the disc (its disc title, performer, composer, arranger, etc.) is recorded.

Notes:

- If your audio component has two COMPU LINK jacks, you can use either one. If it has only one COMPU LINK jack, connect it so that it is the last item in the series of components. (For example, the CD player in the diagram on the left column.)
- If your audio component has two TEXT COMPU LINK jacks, you can use either one. If it has only one TEXT COMPU LINK jack, connect it so that it is the last item in the series of components. (For example, the CD player in the diagram on the left column.)
- "TEXT COMPULINK SOURCE NOT CONNECTED" appears on the display in the following cases:
 - When the connections explained on the left are not correctly done.
 - When you try to use the TEXT COMPULINK function a few seconds after you turn on the connected equipment. This is not a malfunction of the units.
- Refer also to the manuals supplied with your CD player or MD recorder.

IMPORTANT:

If you turn on the receiver before turning on the other components after connecting the components, the TEXT COMPU LINK remote control system does not work correctly.

If this happens:

1. Turn off all the components including this receiver.
2. Turn on the connected components.
3. Turn on this receiver.

OPERATIONS:

To use this remote control system, you need to connect the **main room TV to the MONITOR OUT jack** (see page 12), and the **sub-room TV to the SUB ROOM MONITOR OUT jack** (see page 17) and set the TV's input mode to the proper position to which the receiver is connected.

Make sure you have connected the CD player or MD recorder equipped with the TEXT COMPU LINK remote control system. If not, you cannot use the following functions.

IMPORTANT:

Check to see if the following before/while using the buttons and controls.

• When using the remote control:

- Set the MAIN ROOM/SUB ROOM (LEARN/TRANSMIT) selector to **“MAIN ROOM”** or **“SUB ROOM”** correctly.
- Check the indication shown on the remote's display when you press a button—this indicates the remote control operation mode together with multi-room operation mode (either MAIN ROOM or SUB ROOM) for a while (10 or 5 seconds).

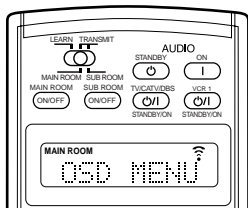
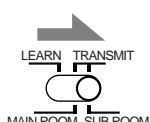
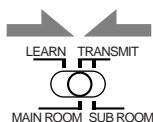

Ex. When you press TEXT DISPLAY with MAIN ROOM/SUB ROOM (LEARN/TRANSMIT) selector set to “MAIN ROOM.”

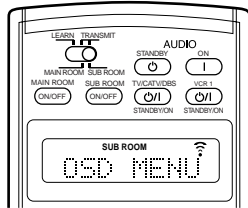

Ex. When you press TEXT DISPLAY with MAIN ROOM/SUB ROOM (LEARN/TRANSMIT) selector set to “SUB ROOM.”

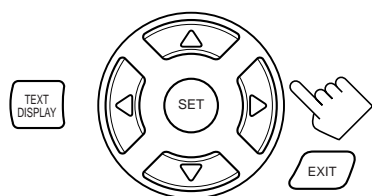

Text display operation buttons

Showing the Disc Information on the TV Screen (Either in the Main Room or in the Sub-Room)

Press **TEXT DISPLAY** while **“CD”** or **“MD”** is selected as the source.

The Disc Information screen appears on the TV.

Disc Information screen

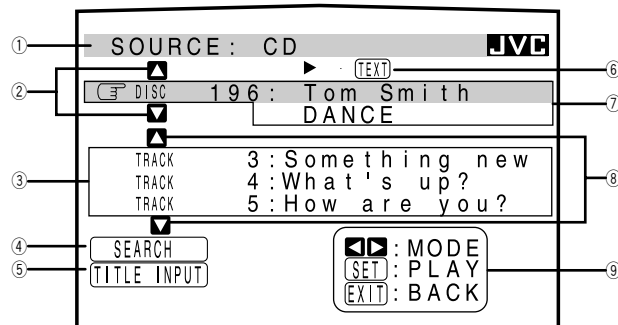

- ① Source name: CD or MD
- ② Select or , then press SET to change the disc.
- ③ Track numbers and track titles.
 - When you move to a track number, you can change the track information by pressing / . Each time you press the button, track information alternates between its track title and its performer. (You can also start playing the track by pressing SET.)
- ④ Select this (move in front), then press SET to go to the DISC SEARCH screen (see page 58).
- ⑤ Select this (move in front), then press SET to go to the TITLE INPUT screen (see page 59).
- ⑥ This appears only when a CD Text is selected.
- ⑦ Disc information such as the disc title, performer, music genre, etc.
 - When this is selected (in front), you can change the disc information by pressing / . Each time you press the button, disc information (see “Note on ⑦”) changes.
- ⑧ Select or , then press SET to change the track.
- ⑨ Usable buttons and their functions for the current selection. Indication here will be changed according to what is currently selected (in front) on the screen. See “Note on ⑨.”

Note on ⑦:

The following information will appear on the display:

- For CD Texts — Disc title, Performer, Genre, Song writer, Composer, Arranger, Message
Only recorded information will be shown. If there is no data, “NO DATA” will appear.
- For MDs — Disc title
If there is no data, “NO DATA” will appear.

Note on ⑨:

For example, the SET button will be used to start play (PLAY), to go to the next screen (ENTER), and to determine the selection (ENTER).

To exit from the Disc information screen:

Press EXIT.

Notes:

- The on-screen display will disappear in the following cases:
 - if no operation is done for about 10 minutes.
 - if you do any operation other than explained in this section.
- To control the MD recorder using the TEXT COMPU LINK remote control system, you have to change the source name shown on the display from “TAPE” to “MD.” (See page 25.)
- Some special characters and marks cannot be displayed correctly.

■ Searching for a Disc (Only for the CD player)

Search for a disc by its performer:

1. Press **TEXT DISPLAY** while “CD” is selected as the source.
The Disc Information screen appears on the TV.
2. Press Δ / ∇ to move \leftarrow to “SEARCH,” then press **SET**.
The DISC SEARCH screen appears.

3. Press Δ / ∇ to move \leftarrow to “PERFORMER,” then press **SET**.
The PERFORMER SEARCH screen appears.

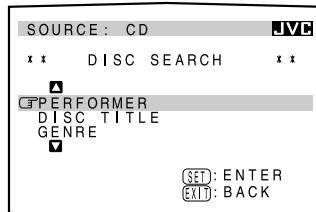

4. Press $\Delta / \nabla / \triangleleft / \triangleright$ to move \leftarrow in front of the first character of the performer you want to search for, then press **SET**.

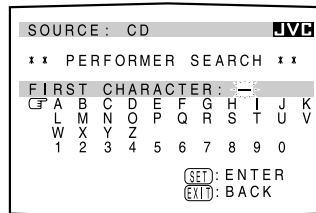

To correct the incorrect entry, press $\Delta / \nabla / \triangleleft / \triangleright$ to move \leftarrow in front of the correct character, then press **SET**.

Note:

Symbols such as @, # or \$ are not available for search.

5. Press **SET** again.
Disc search starts, then the SEARCH RESULT screen, showing the performers, appears.

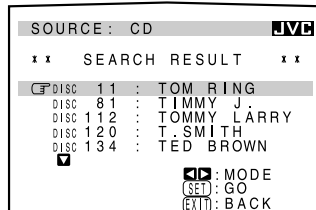

6. On the SEARCH RESULT screen, you can do the following:

- **Changing the indication of the disc information:**
Press Δ / ∇ to move \leftarrow to a searched for disc, then press $\triangleleft / \triangleright$. Each time you press $\triangleleft / \triangleright$, the disc information alternates between its performer and its disc title.
- **Starting a disc play and going to the Disc Information screen (see page 57):** Press Δ / ∇ to move \leftarrow to a searched for disc, then press **SET**.
- **Showing unseen disc information (if more than 5 discs are listed as a result of the search):** Press Δ / ∇ until they appear.
- **Going back to the PERFORMER SEARCH screen:** Press **EXIT**.

Search for a disc by its disc title:

1. Press **TEXT DISPLAY** while “CD” is selected as the source.
The Disc Information screen appears on the TV.
2. Press Δ / ∇ to move \leftarrow to “SEARCH,” then press **SET**.
The DISC SEARCH screen appears.
3. Press Δ / ∇ to move \leftarrow to “DISC TITLE,” then press **SET**.
The DISC TITLE SEARCH screen appears.

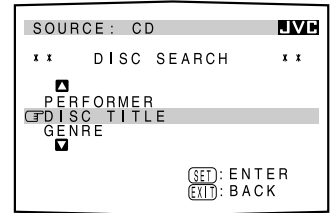

4. Press $\Delta / \nabla / \triangleleft / \triangleright$ to move \leftarrow in front of the first character of the disc title you want to search for, then press **SET**.

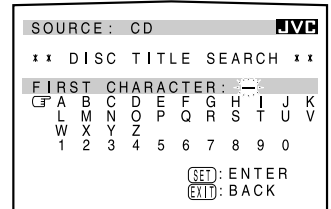

To correct the incorrect entry, press $\Delta / \nabla / \triangleleft / \triangleright$ to move \leftarrow in front of the correct character, then press **SET**.

Note:

Symbols such as @, # or \$ are not available for search.

5. Press **SET** again.
Disc search starts, then the SEARCH RESULT screen, showing the disc titles, appears.

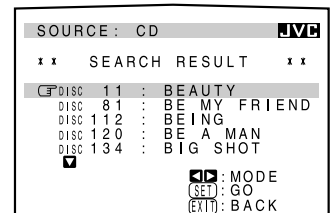

6. On the SEARCH RESULT screen, you can do the following:

- **Changing the indication of the disc information:**
Press Δ / ∇ to move \leftarrow to a searched for disc, then press $\triangleleft / \triangleright$. Each time you press $\triangleleft / \triangleright$, the disc information alternates between its disc title and its performer.
- **Starting a disc play and going to the Disc Information screen (see page 57):** Press Δ / ∇ to move \leftarrow to a searched for disc, then press **SET**.
- **Showing unseen disc information (if more than 5 discs are listed as a result of the search):** Press Δ / ∇ until they appear.
- **Going back to the DISC TITLE SEARCH screen:** Press **EXIT**.

Search for a disc by its genre:

1. Press **TEXT DISPLAY** while “CD” is selected as the source.

The Disc Information screen appears on the TV.

2. Press Δ / ∇ to move \leftarrow to “SEARCH,” then press **SET**.

The DISC SEARCH screen appears.

3. Press Δ / ∇ to move \leftarrow to “GENRE,” then press **SET**.

The GENRE SEARCH screen appears.

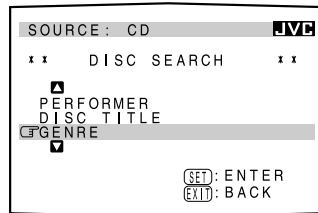

4. Press Δ / ∇ to move \leftarrow to the genre you want to search for, then press **SET**.

To show the unseen genres, press Δ / ∇ until they appear.

Disc search starts, then the SEARCH RESULT screen, showing the disc titles, appears.

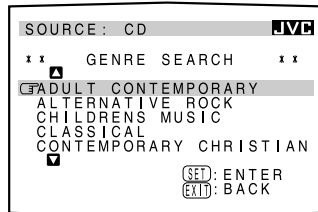

5. On the SEARCH RESULT screen, you can do the following:

- **Changing the indication of the disc information:**

Press Δ / ∇ to move \leftarrow to a searched for disc, then press $\triangleleft / \triangleright$. Each time you press $\triangleleft / \triangleright$, the disc information alternates between its disc title and its performer.

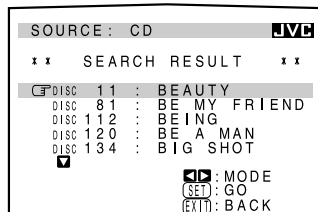

- **Starting a disc play and going to the Disc Information screen (see page 57):** Press Δ / ∇ to move \leftarrow to a searched for disc, then press **SET**.

- **Showing unseen disc information (if more than 5 discs are listed as a result of the search):** Press Δ / ∇ until they appear.

- **Going back to the GENRE SEARCH screen:** Press **EXIT**.

Entering the Disc Information

For the CD Player with the disc memory function:

You can use the disc memory function through this receiver.

The disc information (its performer, disc title, and music genre) of normal audio CDs will be stored into the memory built in the CD player.

For the disc memory function, refer to the manual supplied with your CD player.

- The performer, disc title, and music genre information are usually recorded on a CD Text. However, if a CD Text has no genre information recorded on the disc itself, you can input its music genre by yourself.

Note:

You can enter the TITLE INPUT screens for a CD Text and input its titles. However, you cannot store the titles you have input for a CD Text.

Example: Entering the following information for Disc 1
Performer: “MICHAEL”
Disc title: “MY FAVORITE”

1. Press **TEXT DISPLAY** while “CD” is selected as the source.

The Disc Information screen appears on the TV.

2. Press Δ / ∇ to move \leftarrow to “TITLE INPUT,” then press **SET**.

The TITLE INPUT: PERFORMER screen appears.

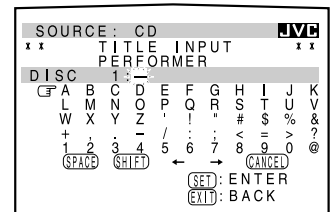

3. Press $\Delta / \nabla / \triangleleft / \triangleright$ to move \leftarrow in front of a character you want, then press **SET** to enter the character.

- If the current CD is a CD Text, go to step 5 without entering the performer.

To use the lower-case letters, press $\Delta / \nabla / \triangleleft / \triangleright$ to move \leftarrow to **(SHIFT)**, then press **SET**.

To use the upper-case letters again, press $\Delta / \nabla / \triangleleft / \triangleright$ to move \leftarrow to **(SHIFT)**, then press **SET**.

4. Repeat step 3 until you finish putting a performer name (up to 32 characters).

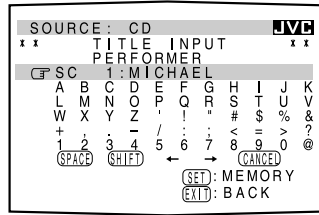

To insert a space, press $\Delta / \nabla / \triangleleft / \triangleright$ to move C to (SPACE), then press SET.

To correct an incorrect character:

- 1) Press $\Delta / \nabla / \triangleleft / \triangleright$ to move C to \leftarrow or \rightarrow , then press SET until the incorrect character is selected.
- 2) Press $\Delta / \nabla / \triangleleft / \triangleright$ to move C to (CANCEL), then press SET to erase the character.
- 3) Press $\Delta / \nabla / \triangleleft / \triangleright$ to move C in front of the correct character, then press SET to enter the correct character.

5. Press $\Delta / \nabla / \triangleleft / \triangleright$ to move C to "DISC 1: MICHAEL (in this example)," then press SET.

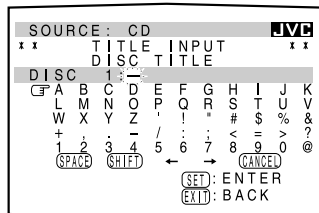

The TITLE INPUT: DISC TITLE screen appears.

6. Enter the disc title, referring to steps 3 and 4.

- If the current CD is a CD Text, go to the next step without entering the disc title.

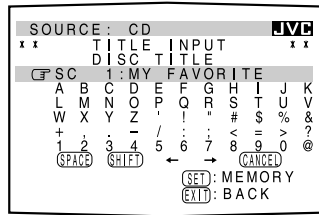

7. Press $\Delta / \nabla / \triangleleft / \triangleright$ to move C to "DISC 1: MY FAVORITE (in this example)," then press SET.

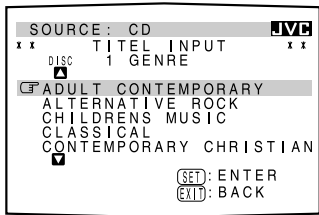

The TITLE INPUT: DISC 1 GENRE screen appears.

8. Press Δ / ∇ to move C to the genre you want, then press SET.

The Disc Information screen appears again.

To show the unseen genres, press Δ / ∇ until they appear.

For the MD recorder:

You can write the disc information (disc title and song titles) into the disc. You can only write the song title for the song currently selected.

- If you have the CD-MD combination deck, you can also enter the disc information (its performer, disc title, and its music genre) of normal audio CDs into the memory built in the CD-MD combination deck. (To do this, follow the procedure of "For the CD Player with the disc memory function" on page 59.)
- If you change the disc or song title including more than 32 characters, the characters following 32nd will be erased from the title.

1. Press TEXT DISPLAY while "MD" is selected as the source.

The Disc Information screen appears on the TV.

2. Press Δ / ∇ to move C to "TITLE INPUT," then press SET.

The DISC TITLE INPUT screen appears.

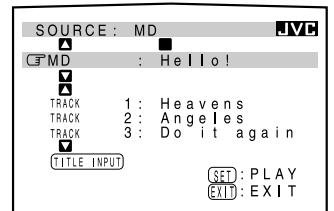

3. Enter the title, referring to steps 3 and 4 of "For the CD Player with the disc memory function" on pages 59 and 60.

- You can enter up to 32 characters for the disc title.

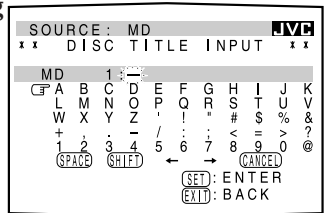

4. Press $\Delta / \nabla / \triangleleft / \triangleright$ to move C to the disc title you have just entered, then press SET.

The disc title is stored into the memory, and the SONG TITLE INPUT screen for the currently selected song appears.

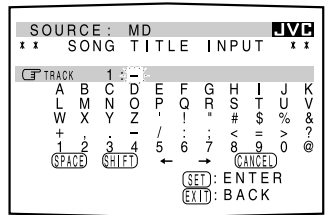

- You can enter a song title for the song currently selected.

5. Enter the song title, referring to steps 3 and 4 of "For the CD Player with the disc memory function" on pages 59 and 60.

- You can enter up to 32 characters for the song title.

6. Press $\Delta / \nabla / \triangleleft / \triangleright$ to move C to the song title you have just entered, then press SET.

The song title is stored into the memory, and the Disc Information screen appears again.

AV COMPU LINK Remote Control System

This receiver is equipped with the AV COMPU LINK-III. The AV COMPU LINK remote control system allows you to operate JVC video components (TV, VCR, and DVD player) through the receiver. To use this remote control system, you need to connect the video components you want to operate, following the procedure below.

- Refer also to the manual supplied with your video components.

1. If you have already plugged your VCR 1 (VCR connected to the VCR 1 jacks), DVD player, TV, and this receiver into the AC outlets, unplug their AC power cords first.
2. Connect the IR signal transmitter (supplied) to the IR OUT on the rear, and place it so that it is aimed at the remote sensor on the target video component(s).
 - See "CONNECTIONS 1" below (and page 15 for details).
3. Connect your VCR 1, DVD player, TV, and this receiver as follows, using the cables with the monaural mini-plugs (not supplied).
 - See "CONNECTIONS 2" below.
4. Connect the audio input/output jacks on VCR 1, DVD player, TV, and this receiver using the cables with RCA pin plug.
 - See pages 11 to 13.
5. Connect the video input/output jacks on VCR 1, DVD player, TV, and this receiver, using the cables with RCA pin plugs, with S-video plugs or with component video plugs.
 - See "CONNECTIONS 3" on the next page (and pages 11 to 13 for details).
6. Plug the AC power cords of the components into the AC outlets.
7. When turning on the TV for the first time after the AV COMPU LINK connection, turn the TV volume to the minimum using the TV volume control on the TV.
8. Turn on the other connected AV components first, then turn on this receiver.
 - When turning on the VCR 1, use the remote control supplied with this receiver—press VCR 1  (STANDBY/ON).

CONNECTIONS 1: IR Signal Transmitter Connection

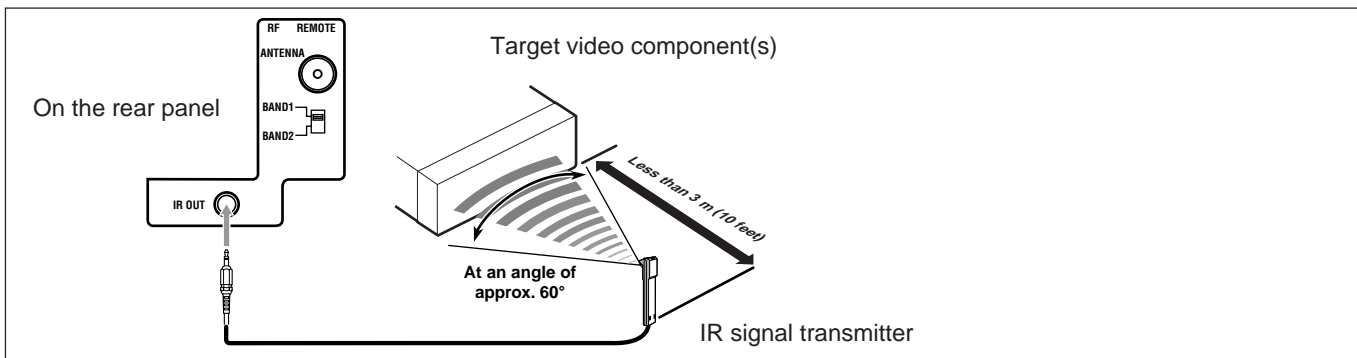

CONNECTIONS 2: AV COMPU LINK Connection

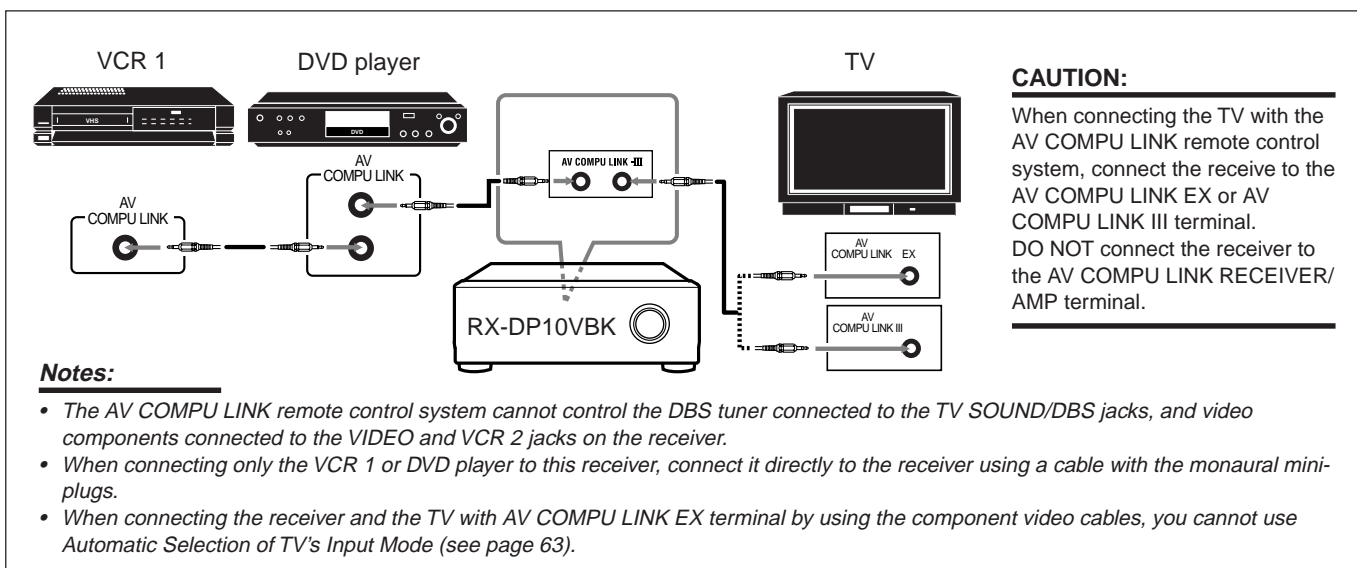

CONNECTIONS 3: Video Cable Connection

This receiver is equipped with three types of the video jacks — S-video, composite video, or component video, and the signals coming into this receiver through one type of video jacks can output only through the terminal of the same type. So you need to connect the VCR and/or DVD player to the TV using only one of the following three ways:

- **When using the AV COMPULINK remote control system, set the component video input correctly** (see “Preparing for the Component Video Input—COMPONENT IN” on page 39); otherwise, the correct input for this receiver will not be selected on the TV

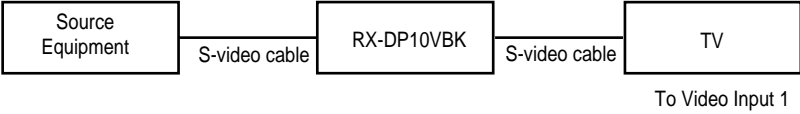
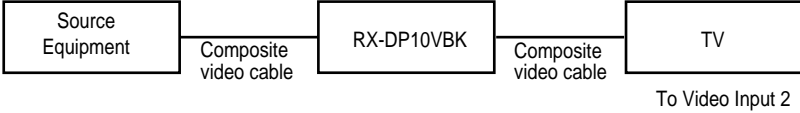
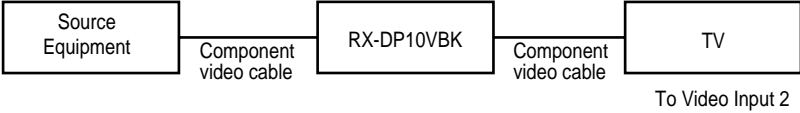
CASE 1	<p>When connecting the source equipment to the receiver through the S-video jacks, connect this receiver to the TV's Video Input 1 terminal using S-video cables.</p> 
CASE 2	<p>When connecting the source equipment to the receiver through the composite video jacks, connect this receiver to the TV's Video Input 2 terminal (composite video input) using composite video cables.</p> 
CASE 3	<p>When connecting the source equipment to the receiver through the component video jacks, connect this receiver to the TV's Video Input 2 terminal (component video input) using component video cables.</p> 

The AV COMPU LINK remote control system allows you to use the five basic functions listed below.

Remote Control of the TV, DVD player, and VCR Using This Remote Control

IMPORTANT:

To operate the video components using the IR signal transmitter (supplied), place it so that it is aimed at the remote sensor(s) on the target video component(s).

- The IR signal transmitter can send signals at a distance of 3 m (10 feet).

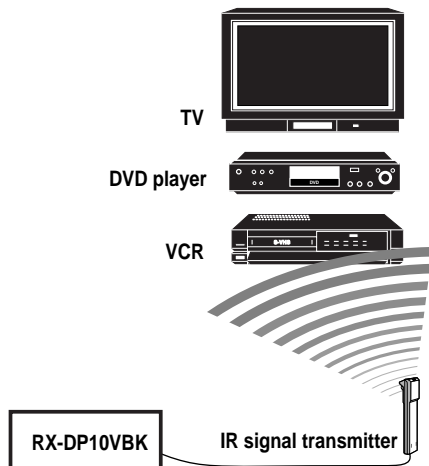

You can control the connected video components using this remote control: Aim the remote control at the remote sensor(s) on the target video component(s) or on the receiver directly.

For details, see page 66.

One-Touch Video Play

- Simply by inserting a video cassette without its safety tab into the VCR 1 (the VCR connected to the VCR 1 jacks), you can enjoy the video playback without setting other switches manually. The receiver automatically turns on and changes the **main room source** to “VCR 1.” The main room TV automatically turns on and changes the input mode to the position so that you can view the playback picture. When you insert a video cassette with its safety tab, press the play (▶) button on the VCR 1 or on its remote control. So, you can get the same result.
 - If the receiver is already turned on with the SUB ROOM ON/OFF lamp on the unit is lit, and source name for the sub-room appears on the display, the receiver changes the **sub-room source** to “VCR 1.” (In this case, the sub-room TV will not turn on.)
- When you press PLAY on the remote control supplied for this receiver for operating the VCR 1, the receiver automatically turns on and changes the **main room source** or **sub-room source** to “VCR 1”—depending on the MAIN ROOM/SUB ROOM (LEARN/TRANSMIT) selector setting on the remote control.
 - For main room operations only: The main room TV automatically turns on and changes the input mode to the appropriate position so that you can view the playback picture.

One-Touch DVD Play

Simply by starting playback on the DVD player, you can enjoy the DVD playback without setting other switches manually.

When you press PLAY on the remote control supplied for this receiver for operating the DVD player, the receiver automatically turns on and changes the **main room source** or **sub-room source**, depending on the MAIN ROOM/SUB ROOM (LEARN/TRANSMIT) selector setting on the remote control, to the appropriate input—"DVD" ("DVD DIGITAL") or "DVD MULTI" as the main room source, and "DVD" as the sub-room source.

For main room operations: The main room TV automatically turns on and changes the input mode to the appropriate position so that you can view the playback picture.

- When the DVD player is connected through the analog input jacks on this receiver (and analog input is selected), the receiver automatically turns on and changes the source to "DVD" or "DVD MULTI."
 - If the receiver is already turned on with the SUB ROOM ON/OFF lamp on the unit lit, and sub-room source name is shown on the display, the receiver changes the **sub-room source** to "DVD." In this case, the sub-room TV will not turn on.
- When the DVD player is connected through the digital input terminal on this receiver (and digital input is selected), the receiver automatically turns on and changes the main room source to "DVD DIGITAL."
 - If the receiver is already turned on with the SUB ROOM ON/OFF lamp on the unit lit, and sub-room source name is shown on the display, the receiver changes the **sub-room source** to "DVD." (If no analog connection is made for the DVD player, no sound comes out of the sub-room front speakers).

Automatic Selection of TV's Input Mode (Only for the Main Room Operations)

- When you select "TV" or "TV DIGITAL" as the **main room source** to play on the receiver, the main room TV automatically changes the input mode to the TV tuner so that you can watch the main room TV.
- When you select "DVD" ("DVD DIGITAL"), "DVD MULTI," "VCR 1," "VCR 2," "VIDEO" or "DBS" ("DBS DIGITAL") as the **main room source** to play on the receiver, the main room TV automatically changes the input mode to the appropriate position (either Video Input 1 or Video Input 2) so that you can view the playback picture.

Notes:

- When you select "TV" or "TV DIGITAL" as the source on the receiver, you cannot see the menu on the TV screen since the AV COMPU LINK remote control system automatically changes the TV's input mode to the TV tuner.
If you do not mind stopping listening to the TV sounds, you can then show the on-screen displays after changing the TV's input mode to the appropriate position (either Video Input 1 or Video Input 2) the receiver is connected to.
- This function does not work when you connect this receiver and the TV with the AV COMPU LINK using the TV's AV COMPU LINK EX terminal. In this case, reconnect the TV referring to case 1 or case 2 on page 62.

Automatic Power On/Off (Standby)

Automatic Power On:

The main room TV, VCR 1 (the VCR connected to the VCR 1 jacks), and DVD player turn on and off along with the receiver.

- When you turn on the receiver by pressing **⏻/| (STANDBY/ON)** on the front panel, or **AUDIO | (ON)** on the remote control with the MAIN ROOM/SUB ROOM (LEARN/TRANSMIT) selector set to "MAIN ROOM":

OR

When you turn on the main room sound by pressing MAIN ROOM ON/OFF while the receiver is turned on:

The MAIN ROOM ON/OFF lamp on the unit lights up and the source name for the main room appears on the display, and;

- If the previously selected **main room source** is "VCR 1," the main room TV and VCR 1 will turn on automatically.
- If the previously selected **main room source** is "DVD" ("DVD DIGITAL") or "DVD MULTI," the main room TV and DVD player will turn on automatically.
- If the previously selected **main room source** is "VIDEO," "VCR 2," "TV" ("TV DIGITAL") or "DBS" ("DBS DIGITAL"), only the main room TV will turn on automatically.

- When you turn on the receiver by pressing **AUDIO | (ON)** on the remote control with the MAIN ROOM/SUB ROOM (LEARN/TRANSMIT) selector set to "SUB ROOM":

OR

When you turn on the sub-room sound by pressing SUB ROOM ON/OFF while the receiver is turned on:

The SUB ROOM ON/OFF lamp lights up, and —

- If the previously selected **sub-room source** is "VCR 1," the VCR 1 will turn on automatically.
- If the previously selected **sub-room source** is "DVD," the DVD player will turn on automatically.
- If the previously selected **sub-room source** is "VIDEO," "VCR 2," or "DBS," nothing happens.

Automatic Power Off (Standby):

- When you turn off the receiver by pressing **⏻/| (STANDBY/ON)** on the unit or **AUDIO ⏻ (STANDBY)** on the remote control, the main room TV, VCR 1 and the DVD player will turn off (standby).
- When you turn off the main room sound by pressing **MAIN ROOM ON/OFF**, the selected **main room source** component turns off (unless the same component is selected as the sub-room source), and the main room TV also turns off.
 - If the SUB ROOM ON/OFF lamp is lit, nothing happens.
- When you turn off the sub-room sound by pressing **SUB ROOM ON/OFF**, the selected **sub-room source** component turns off (unless the same component is selected as the main room source).
 - If the MAIN ROOM ON/OFF lamp is lit, nothing happens.

Note:

*If you turn off the receiver by pressing **⏻/| (STANDBY/ON)** on the unit or **AUDIO ⏻ (STANDBY)** on the remote control, or if you turn off the main room sound by pressing **MAIN ROOM ON/OFF** while recording on the VCR 1, the VCR 1 will not turn off, but continue recording.*

Operating JVC's Audio/Video Components

You can operate JVC's audio and video components with this receiver's remote control, since control signals for JVC components are preset in the remote control.

Operating Audio Components

IMPORTANT:

To operate JVC's audio components using this remote control:

- You need to connect JVC audio components through the COMPU LINK (SYNCHRO) jacks (see page 54) in addition to the connections using cables with RCA pin plugs (see pages 9 and 10).
- Aim the remote control directly at the remote sensor on the receiver.
- To operate a source with the remote control, the source must be selected using source selecting buttons on the remote control.
- To operate the cassette deck or MD recorder using the COMPU LINK remote control system, set the source name correctly. (See page 25.)
- Refer also to the manuals supplied with your components.

When using the remote control:

- Set MAIN ROOM/SUB ROOM (LEARN/TRANSMIT) selector to "MAIN ROOM" or "SUB ROOM" correctly.
- Check the indication shown on the remote's display when you press a button—this indicates the remote control operation mode together with multi-room operation mode (either MAIN ROOM or SUB ROOM) for a while (10 or 5 seconds).
- The CONTROL button can change the remote control operation mode without changing the source. Each time you press the button, the remote control operation mode changes in the sequence—VCR1 → TAPE → CDR → CD DISC → (back to the beginning).

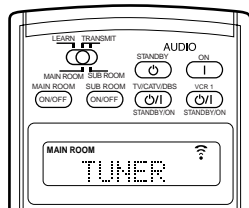
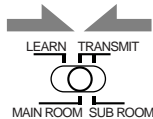

Ex. When you press FM with MAIN ROOM/SUB ROOM (LEARN/TRANSMIT) selector set to "MAIN ROOM."

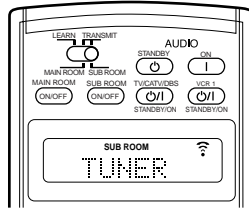
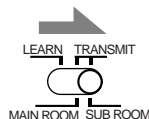

Ex. When you press FM with MAIN ROOM/SUB ROOM (LEARN/TRANSMIT) selector set to "SUB ROOM."

Tuner



You can always perform the following operations:

- FM : Tunes into the last selected FM station.
- AM : Tunes into the last selected AM station.

After pressing FM or AM, you can perform the following operations:

- 1 – 10, +10 : Selects a preset channel number directly.
For channel number 5, press 5.
For channel number 15, press +10, then 5.
For channel number 20, press +10, then 10.
- TUNING UP/DOWN : Tunes into stations.
- FM MODE : Changes the FM reception mode.

Sound control section (Amplifier)

You can always perform the following operations:

- THX ON/OFF : Turns on or off the THX Surround modes—TH X Surround EX or THX Cinema.
- SURROUND ON/OFF : Turns on or off the conventional Surround modes—Dolby Digital, DTS Surround, and Dolby Pro Logic.
- DSP MODE : Selects the DSP modes.
- TEST : Turns on or off the test tone output.

After pressing SOUND, you can perform the following operations:

- FRONT•L then LEVEL +/- : Adjusts the left front speaker channel output level.
- FRONT•R then LEVEL +/- : Adjusts the right front speaker channel output level.
- SUBWFR then LEVEL +/- : Adjusts the subwoofer output level.
- CENTER then LEVEL +/- : Adjusts the center speaker channel output level.
- SURR•L then LEVEL +/- : Adjusts the left surround speaker channel output level.
- SURR•R then LEVEL +/- : Adjusts the right surround speaker channel output level.
- SURR BK•L then LEVEL +/- : Adjusts the left surround back speaker channel output level.
- SURR BK•R then LEVEL +/- : Adjusts the right surround back speaker channel output level.
- EFFECT : Selects the effect level.
- ROOM SIZE : Selects the room size.
- LIVENESS : Selects the liveness.
- WALL : Selects the wall type.
- LINE DIRECT : Turns on or off Line Direct.
- CC CONVERTER : Turns on or off CC Converter.

Notes:

- After adjusting sounds, press the corresponding source selecting button to operate your target source by using the 10 keys; otherwise, the 10 keys cannot be used for operating your target source.
- Each time you press LEVEL + or LEVEL –, the corresponding speaker name appears on the remote's display.

CD player



After pressing CD, you can perform the following operations on the CD player:

- PLAY : Starts playing.
- ◀◀ : Returns to the beginning of the current (or previous) track.
- ▶▶ : Skips to the beginning of the next track.
- STOP : Stops playing.
- PAUSE : Pauses playing. To release it, press PLAY.
- 1 – 10, +10 : Selects a track number directly.
For track number 5, press 5.
For track number 15, press +10, then 5.
For track number 20, press +10, then 10.
For track number 30, press +10, +10, then 10.

CD player-changer



After selecting “CD DISC” by pressing CONTROL repeatedly, you can perform the following operations on a CD player-changer:

- PLAY : Starts playing.
- ◀◀ : Returns to the beginning of the current (or previous) track.
- ▶▶ : Skips to the beginning of the next track.
- STOP : Stops playing.
- PAUSE : Pauses playing. To release it, press PLAY.
- 1 – 6, 7/P : Selects the number of a disc installed in a CD player-changer.

After pressing CD, you can perform the following operations on the CD player-changer:

- 1 – 10, +10 : Selects a track number directly.
For track number 5, press 5.
For track number 15, press +10, then 5.
For track number 20, press +10, then 10.
For track number 30, press +10, +10, then 10.

EXAMPLE:

- Selecting disc number 4, track number 12, and starting playback.
 1. Press CONTROL repeatedly until “CD DISC” appears on the remote’s display, then press 4.
 2. Press CD, then press +10, 2.

If your CD changer is of 200-disc loading capability (except for XL-MC100 and XL-MC301)

You can do the following operations using the number buttons after pressing CD.

1. Select a disc number.
2. Then select a track number (always enter two digits).
3. Start playback.

EXAMPLES:

- Selecting disc number 3, track number 2, and starting playback. Press 3, then, 0, 2, then PLAY.
- Selecting disc number 10, track number 5, and starting playback. Press 1, 0, then, 0, 5, then PLAY.
- Selecting disc number 105, track number 12, and starting playback. Press 1, 0, 5, then 1, 2 then PLAY.

Turntable



After pressing PHONO, you can perform the following operations on a turntable:

- PLAY : Starts playing.
- STOP : Stops operations.

CD recorder



After pressing CDR, or selecting “CDR” by pressing CONTROL repeatedly, you can perform the following operations on a CD recorder:

- PLAY : Starts playing.
- ◀◀ : Returns to the beginning of the current (or previous) track.
- ▶▶ : Skips to the beginning of the next track.
- STOP : Stops playing.
- PAUSE : Pauses playing. To release it, press PLAY.
- 1 – 10, +10 : Selects a track number directly.
For track number 5, press 5.
For track number 15, press +10, then 5.
For track number 20, press +10, then 10.
For track number 30, press +10, +10, then 10.

Notes:

- When you start recording on the CD recorder, use the buttons on the CD recorder itself or on the remote control supplied for it.
- You can use either the CDR or CONTROL button to activate the buttons listed above. If you press CDR, the playing source changes. On the other hand, if you press CONTROL repeatedly to select “CDR,” the playing source does not change.

Cassette deck



After pressing TAPE/MD or selecting “TAPE” by pressing CONTROL repeatedly, you can perform the following operations on a cassette deck:

- PLAY : Starts playing.
- REW : Fast-winds the tape from right to left.
- FF : Fast-winds the tape from left to right.
- STOP : Stops operations.
- PAUSE : Pauses playing. To release it, press PLAY.
- REC : Press this button together with the PLAY button to start recording (for the main room operation only). Press this button together with the PAUSE button to enter recording pause (for the main room operation only).

Notes:

- When connecting the cassette recorder to the TAPE/MD jacks, change the source name to “TAPE”—initial setting (see page 25).
- You can use either the TAPE/MD or CONTROL button to activate the buttons listed above. If you press TAPE/MD, the playing source changes. On the other hand, if you press CONTROL repeatedly to select “TAPE,” the playing source does not change.

MD recorder



After pressing TAPE/MD, you can perform the following operations on the MD recorder:

- PLAY : Starts playing.
- ◀◀ : Returns to the beginning of the current (or previous) track.
- ▶▶ : Skips to the beginning of the next track.
- STOP : Stops playing.
- PAUSE : Pauses playing. To release it, press PLAY.
- REC : Press this button together with the PLAY button to start recording (for the main room operation only). Press this button together with the PAUSE button to enter recording pause (for the main room operation only).

Note:

When connecting an MD recorder to the TAPE/MD jacks, change the source name to “MD” (see page 25).

Operating Video Components

IMPORTANT:

To operate JVC's video components using this remote control:

- You need to connect JVC video components through the AV COMPU LINK jacks (see page 61) in addition to the connections using cables with RCA pin plugs (see pages 11 to 13).
- Some JVC VCRs can accept two types of the control signals—remote codes “A” and “B.” Before using this remote control, make sure that the remote control code of the VCR connected to the VCR 1 jacks is set to code “A.”
 - When another JVC VCR is connected to the VCR 2 and VIDEO jacks, set its remote control code to code “B.” (This remote control cannot emit the control signals of code “B.”)
- To operate the video component(s) using the remote control:
 - Aim the remote control directly at the remote sensor on each component, not on the receiver.
- To operate the video component(s) using the RF signals emitted from this remote control, the IR signal transmitter and the RF rod antenna must be connected to this receiver.
 - Place the IR signal transmitter so that it is aimed at the remote sensor(s) on the target video component(s).
 - The RF signal-reachable distance may differ depending on the operating conditions and circumstances.
 - The IR signal transmitter can send signals at a distance of 3 m (10 feet).

When using the remote control:

- Set the MAIN ROOM/SUB ROOM (LEARN/TRANSMIT) selector to “MAIN ROOM” or “SUB ROOM” correctly.

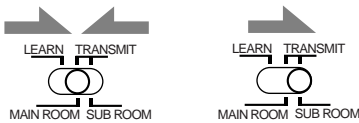

- Set the TV operation mode selector to “TV” or “CATV/DBS” correctly. To operate TV, set it to “TV.”
- Check the indication shown on the remote's display when you press a button—this indicates the remote control operation mode together with multi-room operation mode (either MAIN ROOM or SUB ROOM) for a while (10 or 5 seconds).
- The CONTROL button can change the remote control operation mode without changing the source. Each time you press the button, the remote control operation mode changes in the sequence—VCR1 → TAPE → CDR → CD DISC → (back to the beginning).

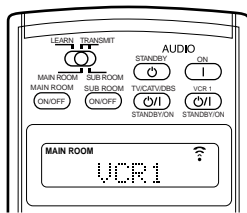
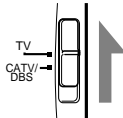

Ex. When you press VCR1 with MAIN ROOM/SUB ROOM (LEARN/TRANSMIT) selector set to “MAIN ROOM.”

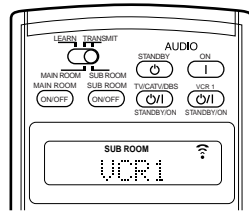

Ex. When you press VCR1 with MAIN ROOM/SUB ROOM (LEARN/TRANSMIT) selector set to “SUB ROOM.”

VCR (VCR connected to the VCR 1 jacks)



You can always perform the following operations:

VCR 1 (STANDBY/ON): Turns on or off the VCR.

After pressing VCR 1 or selecting “VCR1” by pressing CONTROL repeatedly, you can perform the following operations on a VCR:

- 1 – 9, 0 : Selects the TV channels on a VCR.
- PLAY : Starts playing.
- REW : Rewinds a tape.
- FF : Fast-winds a tape.
- STOP : Stops operations.
- PAUSE : Pauses playing. To release it, press PLAY.
- REC : Press this button together with the PLAY button to start recording (only for the main room operations). Press this button together with the PAUSE button to enter recording pause (only for the main room operations).

CHANNEL +/- : Changes the TV channels on a VCR.

Note:

You can use either the VCR 1 button or the CONTROL button to activate the buttons listed above. If you press VCR 1, the playing source also changes. On the other hand, if you press CONTROL repeatedly to select “VCR1” on the remote's display, the playing source does not change.

DVD player



After pressing DVD (or DVD MULTI: only for the main room operations), you can perform the following operations on a DVD player:

- 1 – 10, 0, +10 : Selects the DVD titles or the chapters.
- PLAY : Starts playing.
- ◀◀ : Returns to the beginning of the current (or previous) chapter.
- ▶▶ : Skips to the beginning of the next chapter.
- STOP : Stops playing.
- PAUSE : Stops playing temporarily. To release it, press PLAY.

After pressing DVD MENU (only for the main room operations), these buttons can be used for the DVD menu operations.

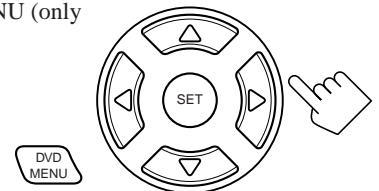

Note:

Refer also to the manual supplied for your DVD player (and the instruction supplied for the discs).

TV

You can always perform the following operations (with the TV operation mode selector set to “TV”):

- TV/CATV/DBS (STANDBY/ON): Turns on or off the TV.
- TV VOL +/- : Adjusts the volume.
- TV/VIDEO : Sets the input mode (either TV or VIDEO).

After pressing TV/DBS (with the TV operation mode selector set to “TV”), you can perform the following operations on a TV:

- CHANNEL +/- : Changes the channels.
- 1 – 9, 0, 100+ : Selects the channels.
- RETURN : Alternates between the previously selected channel and the current channel.

Operating Other Manufacturers' Equipment

You can use this remote control supplied for this unit for operating the other manufacturers' components, either by changing the preset signal codes or by using the learning function (see page 71).

IMPORTANT:

- To operate the other component(s) using the RF signals emitted from this remote control, the IR signal transmitter and the RF rod antenna must be connected to this receiver.
 - Place the IR signal transmitter so that it is aimed at the remote sensor(s) on the target component(s).
 - The RF signal-reachable distance may differ depending on the operating conditions and circumstances.
 - The IR signal transmitter can send signals at a distance of 10 feet (3 m).

When using the remote control:

- Set the MAIN ROOM/SUB ROOM (LEARN/TRANSMIT) selector to "MAIN ROOM" or "SUB ROOM" correctly.

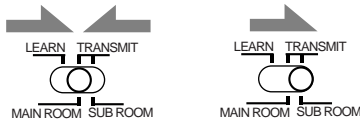

- Set the TV operation mode selector to "TV" or "CATV/DBS" correctly.

To operate TV, set it to "TV."

To operate the CATV converter or the DBS tuner, set it to "CATV/DBS."

- Check the indication shown on the remote's display when you press a button—this indicates the remote control operation mode together with multi-room operation mode (either MAIN ROOM or SUB ROOM) for a while (10 or 5 seconds).

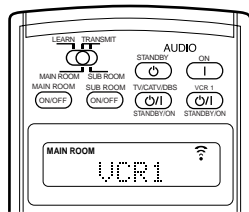

Ex. When you press VCR1 with MAIN ROOM/SUB ROOM (LEARN/TRANSMIT) selector set to "MAIN ROOM."

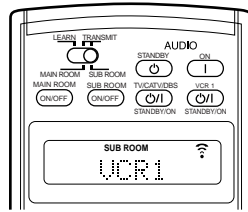

Ex. When you press VCR1 with MAIN ROOM/SUB ROOM (LEARN/TRANSMIT) selector set to "SUB ROOM."

CAUTION:

When replacing the batteries, finish it without delay; otherwise, manufactures' codes are lost.

Changing the Preset Signal Codes

By changing the transmittable signals from preset ones to the other manufacturers', you can operate the other manufacturer's components using this remote control.

- When operating the other manufacturers' components, refer also to the manuals supplied with them.

To change the transmittable signals for operating another manufacturer's TV

- Set the TV operation mode selector to "TV."

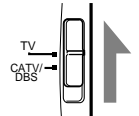

- Press and hold TV/CATV/DBS \odot/I (STANDBY/ON).

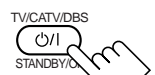

- Press TV/DBS.

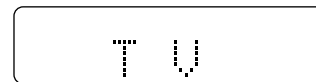

Remote's display

- Enter manufacturer's code using buttons 1-9, and 0.

See page 69 to find the code.



- Release TV/CATV/DBS \odot/I (STANDBY/ON).

After setting the TV operation mode selector to "TV," you can perform the following operations on the TV:

TV/CATV/DBS \odot/I (STANDBY/ON):

Turns on or off the TV.

TV VOL +/- : Adjusts the volume.

TV/VIDEO : Sets the input mode (either TV or VIDEO).

After pressing TV/DBS (with the TV operation mode selector set to "TV"), you can perform the following operations on a TV:

CHANNEL +/- : Changes the channels.

1 - 10, 0, 100+ (+10) : Selects the channels.

Number button 10 will function as the ENTER button if your TV requires pressing ENTER after selecting a channel number.



Notes:

- Refer to the manual supplied for your TV.
- All the functions listed above may not be assigned to the buttons for some TVs.
- If you cannot change the channels of some TVs by pressing number buttons, press CHANNEL +/- for changing the channels.

- Try to operate your TV by pressing TV/CATV/DBS \odot/I (STANDBY/ON).

When your TV turns on or off, you have entered the correct code.

If there are more than one code listed for your brand of TV, try each one until the correct one is entered.

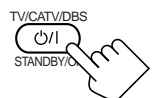

To change the transmittable signals for operating a CATV converter and DBS tuner

1. Set the TV operation mode selector to "CATV/DBS."

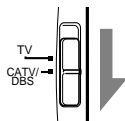

2. Press and hold TV/CATV/DBS \odot /I (STANDBY/ON).

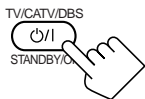

3. Press TV/DBS.



Remote's display



4. Enter manufacturer's code using buttons 1–9, and 0.

See page 70 to find the code.



5. Release TV/CATV/DBS \odot /I (STANDBY/ON).

After setting the TV operation mode selector to "CATV/DBS," you can turn on and off the CATV converter or the DBS tuner:

TV/CATV/DBS \odot /I (STANDBY/ON):

Turns on or off the CATV converter or DBS tuner.



After pressing TV/DBS (with TV operation mode selector set to "CATV/DBS"), you can perform the following operations on the CATV converter or on the DBS tuner:

CHANNEL +/- : Changes the channels.

1 – 10, 0, 100+ (+10) : Selects the channels.
Number button 10 will function as the ENTER button if your equipment requires pressing ENTER after selecting a channel number.

Note:

Refer to the manual supplied for your CATV converter or DBS tuner.

6. Try to operate your CATV converter or DBS tuner by pressing TV/CATV/DBS \odot /I (STANDBY/ON).

When your CATV converter or DBS tuner turns on or off, you have entered the correct code.

If there are more than one code listed for your brand of CATV converter or DBS tuner, try each one until the correct one is entered.

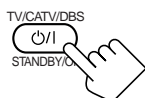

Note:

You cannot preset the signals for both of the CATV converter and DBS tuner at the same time.

To change the transmittable signals for operating another manufacturer's VCR

1. Press and hold VCR 1 \odot /I (STANDBY/ON).

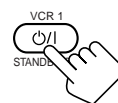

2. Press VCR 1.



Remote's display

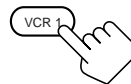

3. Enter manufacturer's code using buttons 1–9, and 0.

See page 70 to find the code.

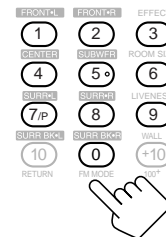

4. Release VCR 1 \odot /I (STANDBY/ON).

The following button can be used for operating the VCR :

VCR 1 \odot /I (STANDBY/ON):

Turns on or off the VCR.



After pressing VCR 1, you can perform the following operations on the VCR:

1 – 10, 0, 100+ (+10) : Selects the TV channels.

Number button 10 will function as the ENTER button if your VCR requires pressing ENTER after selecting a channel number.

PLAY : Starts playback.

REW : Rewinds a video tape.

FF : Fast-winds a video tape.

STOP : Stops operation.

PAUSE : Pauses.

● REC : Press this button together with the PLAY button to start recording (only for the main room operation).

Press this button together with the PAUSE button to enter recording pause (only for the main room operation).

CHANNEL +/- : Changes the TV channels on the VCR.

Note:

Refer to the manual supplied for your VCR.

5. Try to operate your VCR by pressing VCR 1 \odot /I (STANDBY/ON).

When your VCR turns on or off, you have entered the correct code.

If there are more than one code listed for your brand of VCR, try each one until the correct one is entered.

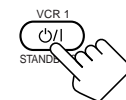

To change the transmittable signals for operating a DVD player

1. Press and hold VCR 1  (STANDBY/ON).

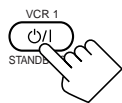

2. Press DVD.

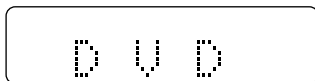

Remote's display

3. Enter manufacturer's code using buttons 1–9, and 0.

See page 70 to find the code.



4. Release VCR 1  (STANDBY/ON).

After pressing DVD (or DVD MULTI only for the main room operation), you can perform the following operations on a DVD player:

- 1 – 9, 0, +10 : Selects the titles or the chapters.
- PLAY : Starts playing.
- ◀◀ : Returns to the beginning of the current (or previous) chapter.
- ▶▶ : Skips to the beginning of the next track.
- STOP : Stops playing.
- PAUSE : Stops playing temporarily. To release it, press PLAY.



After pressing DVD MENU (only for the main room operations), these buttons can be used for the DVD menu operations.

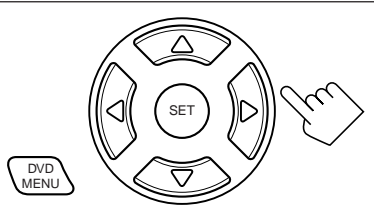

Note:

Refer also to the manual supplied for your DVD player (and the instruction supplied for the discs).

5. Try to operate your DVD player by pressing one of the above buttons.

- DO NOT forget to turn on the DVD player before pressing one of the above buttons.

If there are more than one code listed for your brand of DVD player, try each one until the correct one is entered.

To change the transmittable signals for operating a CD player

1. Press and hold AUDIO  (ON).

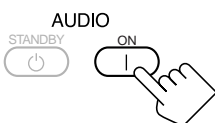

2. Press CD.

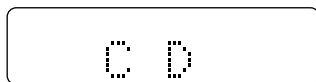
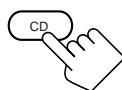

Remote's display

3. Enter manufacturer's code using buttons 1–9, and 0.

See page 70 to find the code.

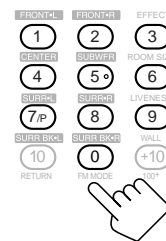

4. Release AUDIO  (ON).

After pressing CD, you can perform the following operations on a CD player:

- 1 – 9, 0, +10 : Selects the tracks.
- PLAY : Starts playing.
- REW : Fast-reverses the tracks.
- FF : Fast-forwards the tracks.
- STOP : Stops playing.
- PAUSE : Stops playing temporarily. To release it, press PLAY.



Note:

Refer to the manual supplied for your CD player.

5. Try to operate your CD player by pressing one of the above buttons.

- DO NOT forget to turn on the CD player before pressing one of the above buttons.

If there are more than one code listed for your brand of CD, try each one until the correct one is entered.

Manufacturers' codes for TV

Manufacturer	Codes
JVC	00*, 13, 74
AKAI	01, 02
BLAUPUNKT	03, 04
FISHER	01, 05
GRUNDIG	03, 06, 07
HITACHI	08, 09, 10, 49, 78
IRADDIO	02
ITT/NOKIA	11, 12
LOEWE	06, 15, 16
MAGNAVOX	08, 17, 49
METS	50, 51, 52, 53
MATSUSHITA	86, 87
MITSUBISHI	08, 18, 19, 20
MIVAR	21
NEC	83
NORDMENDE	22, 23
OKANO	15
PANASONIC	24, 25, 26, 27, 76
PHILIPS	15, 17, 28, 75
PIONEER	85
RCA/PROSCAN	08, 24, 29, 30, 31, 48
SABA	32, 33, 68, 69, 70
SAMSUNG	06, 08, 16, 34, 35, 49
SANYO	01, 05, 81
SCHNEIDER	02, 15, 36
SHARP	37, 38, 77, 88
SONY	39, 80
TELEFUNKEN	40, 41, 42, 69
THOMSON	71, 72
TOSHIBA	37, 43, 44, 79
ZENITH	45, 46

*This figure is set to the remote control as the initial JVC code.

Manufactures' codes for DBS tuner

Manufacturer	Codes
JVC	56, 57*, 67
AMSTRAD	43, 44, 45, 46, 47, 48, 49
BLAUPUNKT	30
ECHOSTAR	50, 51, 67
GOLDSTAR	31
GRUNDIG	32, 33
HIRSHMANN	48, 52, 53, 54, 55
GENERAL INSTRUMENT	68
ITT/NOKIA	34
KATHREIN	52, 58, 59, 60, 61, 62, 63
NEC	35, 36
ORBITECH	48
PHILIPS	37, 38
RCA	65
SAMSUNG	39, 40
SCHWAIGER	61, 64
SIEMENS	41, 42
SONY	66
TECHNISAT	48

*This figure is set to the remote control as the initial JVC code.

Manufactures' codes for CATV converter

Manufacturer	Codes
GENERAL INSTRUMENT	29
HAMLIN/REGAL	01, 02, 03, 04, 05
JERROLD/G	06, 07, 08, 09, 10, 11, 12, 13, 14
OAK	15, 16, 17
PANASONIC	18, 19, 20
PIONEER	21, 22
SCIENTIFFIC ATLANTA	23, 24, 25
TOCOM	26
ZENITH	27, 28

Manufactures' codes for VCR

Manufacturer	Codes
JVC	00*, 28, 29, 58, 83, 84
AIWA	01, 02, 82
BELL & HOWELL	03
BLAUPUNKT	04, 05
CGM	06, 07
EMERSON	08, 10, 11, 12, 64, 65
FISHER	03, 14, 15, 16, 17
FUNAI	01, 76
GE	18, 19, 20
GOLDSTAR	07
GOODMANS	13, 21
GRUNDIG	06, 22
HITACHI	18, 23, 24, 25, 66, 74
LOEWE	07, 21
MAGNAVOX	04, 19, 24
MATSUSHITA	77, 78
MITSUBISHI	30, 31, 32, 33, 34, 35, 80, 81
NEC	26, 27
NOKIA	03, 36
NORDMENDE	38
ORION	09
PANASONIC	19, 24, 39, 40, 79
PHILIPS	04, 19, 21, 24, 41, 42
PHONOLA	21
PIONEER	73
RCA/PROSCAN	04, 18, 19, 23, 24, 43, 44, 45
SABA	38, 46
SAMSUNG	45, 47, 59, 61, 62, 63
SANYO	03, 48, 49
SHARP	37, 50, 75
SIEMENS	03, 51
SONY	52, 53, 54, 68, 69, 70
TELEFUNKEN	55, 60
TOSHIBA	43, 44, 71, 72
ZENITH	56, 57

*This figure is set to the remote control as the initial JVC code.

Manufactures' codes for DVD player

Manufacturer	Codes
JVC	00*, 02
DENON	01
PANASONIC	03
PHILIPS	13
PIONEER	04, 05, 06
RCA	07
SAMSUNG	08
SONY	09
TOSHIBA	10
YAMAHA	11, 12

*This figure is set to the remote control as the initial JVC code.

Manufactures' codes for CD player

Manufacturer	Codes
JVC	00*, 09
DENON	01, 02, 03
FISHER	04, 05
KENWOOD	10, 11, 12, 13, 14
MAGNAVOX	15, 16
MARANTZ	17
ONKYO	18, 19, 20, 21
PANASONIC	22, 23, 24
PHILIPS	25, 26, 27, 28, 29
PIONEER	30, 31
RCA	32, 33, 34
SANYO	35
SHARP	36
SONY	53
TEAC	37, 38, 39
TECHNICS	40, 41, 42, 43, 45
YAMAHA	46, 47, 48, 49, 50, 51, 52

*This figure is set to the remote control as the initial JVC code.

Note:

Manufacturers' codes are subject to change without notice. If they are changed, this remote control cannot operate the equipment.

Storing the Remote Signals Manually

You can store the signals into the learning buttons by sending the signals you want to store from another remote control. This function is called “Learning Function.”

The learning buttons

The highlighted buttons in the illustration below are the learning buttons you can store signals into.

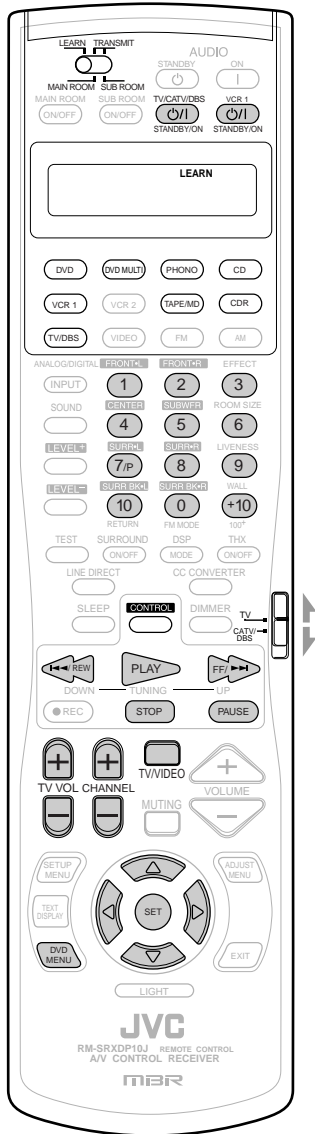

To store the signals

Before storing another manufacturer’s signals, make sure that the manufacturer’s remote control unit (hereafter called “target remote control”) actually works.

1. Set the **LEARN/TRANSMIT (MAIN ROOM/SUB ROOM)** selector to “**LEARN.**”

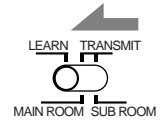

2. Place the two remote controls on a level surface with signal transmitting windows facing each other.

- Leave a space of 5 to 10 cm (2 to 4 inches) between the two remote controls; otherwise, storing may be failed.

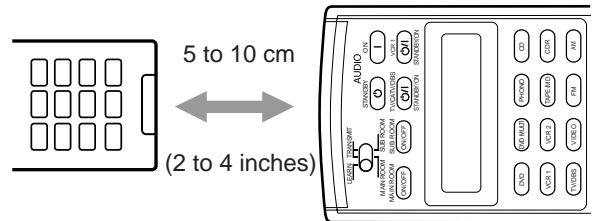

3. Press one of the source selecting buttons (except **VCR2, VIDEO, FM, and AM**).

The selected source name appears on the display.

- If possible, select the source corresponding to the target remote control’s usage.



Ex. When you press CD.



Notes:

- Before pressing the TV/DBS button, select the TV operation mode selector to the desired position. You can store different signals into the 10 keys each for the TV, and the CATV converter or the DBS tuner.
- If you want to store signals for the CD changer, press **CONTROL** repeatedly until “CD DISC” appears on the remote’s display.



4. Press one of the learning buttons, to which you want to assign a signal from the target remote control.

The LEARN indicator starts flashing.

- If you have pressed **DVD** or **DVD MULTI** in step 3, you can store the signals into the following buttons.

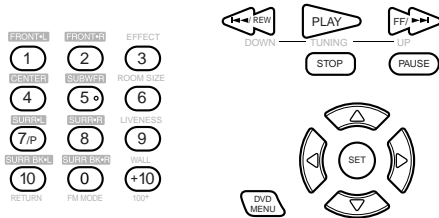

- If you have pressed “**TV/DBS**” in step 3, you can store the signals into the following buttons:
 - By setting the TV operation mode selector either to “**TV**” or “**CATV/DBS**,” you can store a different set of signals into the following buttons.

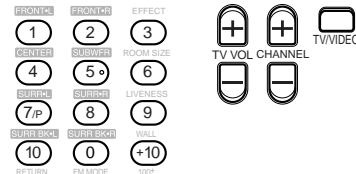
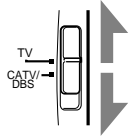

- If you have pressed **PHONO** in step 3, you can store the signals into the following buttons.



5. While the LEARN indicator is flashing, press the button on the target remote control.

The signal from the target remote control is sent to this remote control.

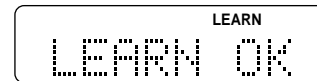

- If you have pressed **CD**, or **CONTROL** to select “**CD DISC**,” in step 3, you can store the signals into the following buttons.
 - You can store a different set of signals into the following buttons separately for “**CD**” and “**CD DISC**.”

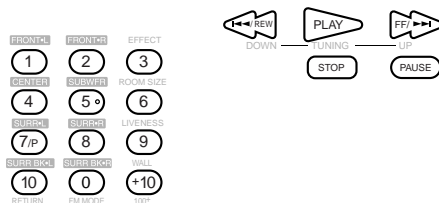

“**LEARN OK**” appears and the LEARN indicator stops flashing and remains lit. The target signal is now stored in the button selected in step 4.

Notes:

- If the LEARN indicator stops flashing before you press the button on the target remote control, repeat from step 4 again.
- If “**ERROR**” appears on the display, you have failed in storing the signal. Try again. However some signals do not match to this remote control even though this remote control can learn most infrared signals.

- If you have pressed “**TAPE/MD**” or “**CDR**” in step 3, you can store the signals into the following buttons.

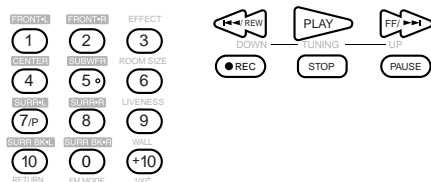

- Repeat steps 4 to 5 to store more signals in the same remote mode (source).
- Repeat steps 3 to 5 to store more signals in a different remote mode (source).

7. Set the LEARN/TRANSMIT (MAIN ROOM/SUB ROOM) selector to “TRANSMIT (MAIN ROOM/SUB ROOM)” to finish the storing procedure.

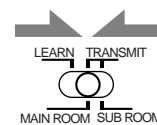

For the main room operations

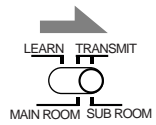

For the sub-room operations

- If you have pressed **VCR1** in step 3, you can store the signals into the following buttons.

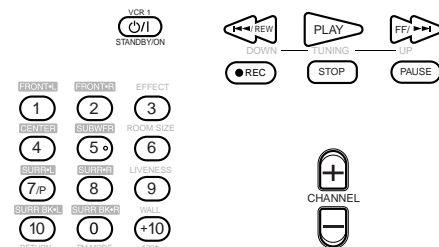

Notes:

- The signals stored into this remote control from the target remote control deviate slightly from the original signals. Since some components will not accept these deviating signals, you may not be able to operate those components using this remote control even though the storing procedure has been successfully finished.
- When replacing the batteries, finish it without delay; otherwise, the stored signals are all erased.

To use the stored signals

When you want to use the stored signals, follow the procedure below.

IMPORTANT:

To operate the other component(s) using this remote control—

- Aim directly at the remote sensor(s) on the target component(s).
– This remote control can send signals at a distance of 7 m (23 feet).

OR

- You can also use the IR signal transmitter connected to this receiver.
– Place the IR signal transmitter so that it is aimed at the remote sensor(s) on the target component(s).
You can operate the other component(s) through the remote sensor on this receiver.

When using the remote control:

- Set the MAIN ROOM/SUB ROOM (LEARN/TRANSMIT) selector to “MAIN ROOM” or “SUB ROOM” correctly.

1. Set the LEARN/TRANSMIT (MAIN ROOM/SUB ROOM) selector to “TRANSMIT (MAIN ROOM/SUB ROOM).”

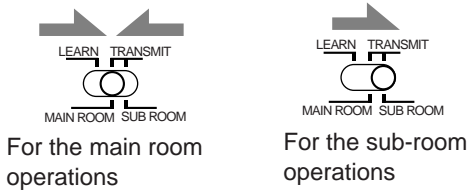

2. Press one of the source selecting buttons (or CONTROL repeatedly) to select the desired remote control operation mode (source).

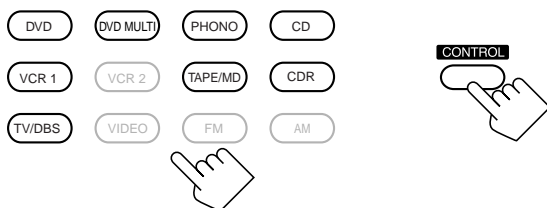

3. Press the desired button.

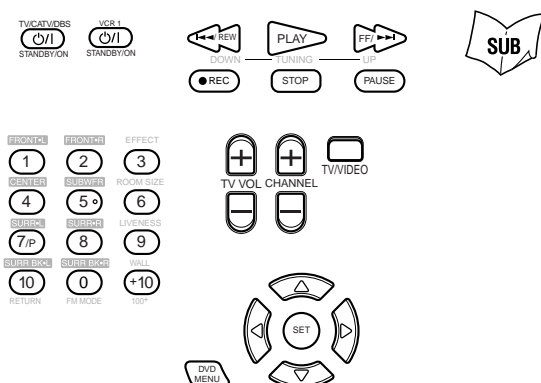

Notes:

- When you press TV/CATV/DBS (STANDBY/ON), set the TV operation mode selector correctly.
- To use the following buttons, you can skip step 2 above.
– VCR1 (STANDBY/ON), TV VOL +/-, TV/VIDEO, DVD MENU
- To use the following buttons, press DVD MENU first.
– SET, / / /

To erase the stored signals

After erasing the stored signals, preset signals are resumed and you can operate JVC's components again.

1. Set the LEARN/TRANSMIT (MAIN ROOM/SUB ROOM) selector to “LEARN.”

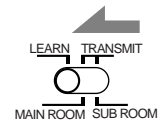

2. Press and hold EXIT, then press one of the source selecting buttons from which you want to erase the stored signals.

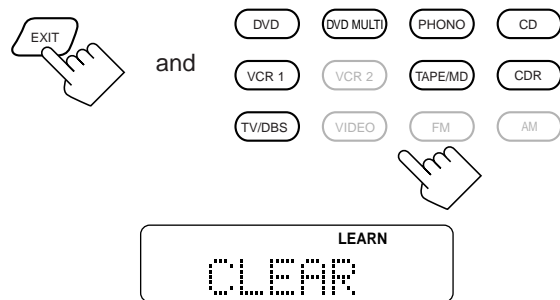

“CLEAR” appears on the display, and all the signals stored in the selected remote mode (source) are erased at the same time.

Notes:

- You cannot erase a signal assigned to a particular button only. Storing a new signal to a particular button erases the previously stored signal.
- To erase the stored signals for “CD DISC,” first press CONTROL to select “CD DISC,” then press CONTROL again while holding EXIT this time.



3. Set the LEARN/TRANSMIT (MAIN ROOM/SUB ROOM) selector to “TRANSMIT (MAIN ROOM/SUB ROOM)” to finish the erasing procedure.

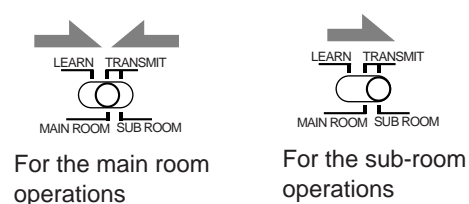

Troubleshooting

Use this chart to help you solve daily operational problems. If there is any problem you cannot solve, contact your JVC service center.

PROBLEM	POSSIBLE CAUSE	SOLUTION
The display does not light up.	The power cord is not plugged in.	Plug the power cord into an AC outlet. (See page 16.)
The buttons and controls on the front panel do not work.	The Multi-room function is not set correctly.	<ul style="list-style-type: none"> • Press MAIN ROOM ON/OFF for the main room operations. • Press SUB ROOM ON/OFF and SUB ROOM CONTROL for the sub-room operations.
No sound from the speakers in the main room.	Speaker signal cables are not connected properly.	Check speaker wiring and reconnect if necessary. (See page 8.)
	The SPEAKERS 1 and SPEAKERS 2/SUB ROOM buttons are not set correctly.	Press SPEAKERS 1 and SPEAKERS 2/SUB ROOM correctly. (See page 23.)
	An incorrect source is selected for the main room.	Select the correct source for the main room.
	Muting is activated for the main room source.	Press MUTING to cancel the mute. (See page 24.)
	An incorrect input mode (analog or digital) is selected.	Select the correct input mode (analog or digital). (See page 23.)
	Connections are incorrect.	Check connections. For analog connections, see pages 9 to 13. For digital connections, see page 14.
No sound from the front speakers in the sub-room.	Speaker signal cables are not connected properly.	Check speaker connection and reconnect if necessary. (See page 17.)
	Main/sub setting for the speakers connected to the FRONT 2/SUB ROOM terminals are not set correctly.	Set the main/sub setting for the speakers correctly to use them as the sub-room front speakers. (See page 40.)
	Amplifier connected to the SUB ROOM PREOUT is not turned on.	Turn on the amplifier.
	An incorrect source is selected for the sub-room.	Select the correct sub-room source.
	Muting is activated for the sub-room source.	Press MUTING to cancel the mute. (See page 30.)
	Connections are incorrect.	Check connections. For analog connections, see pages 9 to 13.
The sub-room speaker connected to the FRONT 2/SUB ROOM SPEAKERS cannot be activated.	The Surround/DSP mode is used for the main room.	Cancel the Surround/DSP mode in the main room.
Surround cannot be used for the main room sources.	Sub-room sound is activated (the SUB ROOM indicator is lit on the display).	Deactivating the sub-room sound will allow you to use the Surround in the main room.
CD tracks are skipped, tape is rewind, or radio station is changed unintentionally.	When the same source is selected both for the main room and the sub-room, the source in one room affects the source in the other room.	This is normal, not the malfunction of the unit. Selecting different sources for the main room and the sub-room will avoid these troubles.
The receiver does not work correctly as you operate it.	Main room and sub-room operations are done at the same time.	If this happens, perform the same operation again.

Continued on the next page.

PROBLEM	POSSIBLE CAUSE	SOLUTION
Continuous hissing or buzzing during FM reception.	Incoming signal is too weak.	Connect an outdoor FM antenna or contact your dealer. (See page 6.)
	The station is too far away.	Select a new station.
	An incorrect antenna is used.	Check with your dealer to be sure you have the correct antenna.
	Antennas are not connected properly.	Check connections. (See page 6.)
Occasional cracking noise during FM reception.	Ignition noise from automobiles.	Move the antenna farther from automobile traffic.
Noise is heard during record playing.	A ground cable of the turntable is not connected to the screw marked (⌘).	Connect it to the screw marked (⌘).
Howling during record playing.	Your turntable is too close to speakers.	Move speakers away from the turntable.
No sound effect such as DSP mode and Parametric Equalizer.	The Line Direct function is turned on.	Turn off the Line Direct function. (See page 25.)
“OVERLOAD” starts flashing on the display.	Speakers are overloaded because of high volume either in the main room or in the sub-room.	<ol style="list-style-type: none"> 1. Press ⏻/I (STANDBY/ON) on the front panel to turn off the receiver. 2. Stop the playback source. 3. Turn on the receiver again, and adjust the volume.
	Speakers are overloaded because of short circuit of speaker terminals.	Press ⏻/I (STANDBY/ON) on the front panel to turn off the receiver, check the speaker wiring, then press it again to turn on the receiver again. If “OVERLOAD” does not disappear despite speaker wiring is not short-circuited, consult your dealer.
“TURN ON MAIN OR SUB ROOM” appears on the display.	The receiver is turned on with the main room and sub-room sounds deactivated.	<ul style="list-style-type: none"> • Press MAIN ROOM ON/OFF for the main room operations. • Press SUB ROOM ON/OFF for the sub-room operations.
The STANDBY lamp lights up after turning on the power, but soon the receiver turns off again (into standby mode).	The receiver is overloaded because of applying high voltage.	Press ⏻/I (STANDBY/ON) on the front panel to turn off the receiver. After unplugging the AC power cord, consult your dealer.
Remote control does not work.	The MAIN ROOM/SUB ROOM selector is not set correctly.	Set the selector correctly either to “MAIN ROOM” or to “SUB ROOM.”
	The TV operation mode selector is not set correctly.	Set the selector correctly either to “TV” or to “CATV/DBS.”
	The BAND selectors on the rear and on the remote control are set to a different band.	Set both the BAND selectors to the same band (See page 15.)
	RF communication between the receiver and the remote control is interrupted from outside.	Consult your dealer.
	Batteries are weak.	Replace batteries. (See page 16.)
Remote control does not work properly.	An incorrect remote control operation mode is selected.	Select the correct remote control operation mode. (See pages 64 to 73.)
Front door does not open or close.	There is an obstruction disabling the front door from opening or closing.	Remove the obstruction, and turn the unit off then back on again.

Specifications

Amplifier

Output Power

At Stereo operation:

Front channels: **120 W per channel, min. RMS, driven into 8 Ω , 20 Hz to 20 kHz with no more than 0.02% total harmonic distortion.**

120 W per channel, min. RMS, driven into 4 Ω , 20 Hz to 20 kHz with no more than 0.07% total harmonic distortion.

At Surround operation:

Front channels: 120 W per channel, min. RMS, driven into 8 Ω , 20 Hz to 20 kHz with no more than 0.02% total harmonic distortion.

Center channel: 120 W, min. RMS, driven into 8 Ω , 20 Hz to 20 kHz with no more than 0.02% total harmonic distortion.

Surround channels: 120 W per channel, min. RMS, driven into 8 Ω , 20 Hz to 20 kHz with no more than 0.02% total harmonic distortion.

Surround back channels: 120 W per channel, min. RMS, driven into 8 Ω , 20 Hz to 20 kHz with no more than 0.02% total harmonic distortion.

Audio

Audio Input Sensitivity/Impedance (1 kHz):

PHONO (MM): 2.5 mV/47 k Ω
 CD, CDR, TAPE/MD, DVD, VCR 1, VCR 2, VIDEO, TV SOUND/DBS: 200 mV/47 k Ω

Audio Input (DIGITAL IN)* :

Coaxial: DIGITAL 1 (DVD): 0.5 V(p-p)/75 Ω
 Optical: DIGITAL 2 (CD) / 3(TV) / 4(CDR) / 5(MD): -21 dBm to -15 dBm (660 nm \pm 30 nm)
 * Corresponding to Linear PCM, Dolby Digital, and DTS Digital Surround (with sampling frequency — 32 kHz, 44.1 kHz, 48 kHz)

Audio Output Level: SUB ROOM PREOUT: 200 mV
 PREOUT: 1 V

Recording Output Level: TAPE/MD, CDR, VCR 1, VCR 2: 200 mV

Digital output: Optical: DIGITAL OUTPUT
 Signal wave length: 660 nm
 Output level: -21 dBm to -15 dBm

Signal-to-Noise Ratio (*66 IHF/78 IHF):

PHONO: 70 dB/78 dB (at REC OUT)
 CD, CDR, TAPE/MD, DVD, VCR 1, VCR 2, VIDEO, TV SOUND/DBS: 92 dB/80 dB (Line Direct On)

Frequency Response (8 Ω):

PHONO 20 Hz to 20 kHz (\pm 1 dB)
 CD, CDR, TAPE/MD, DVD, VCR 1, VCR 2, VIDEO, TV SOUND/DBS: 10 Hz to 100 kHz (+1 dB, -3 dB)

RIAA Phono Equalization:

\pm 1.0 dB (20 Hz to 20 kHz)

Video

Video Input Sensitivity/Impedance:

Composite video: DVD, VCR 1, VCR 2, VIDEO, TV SOUND/DBS: 1 V(p-p)/75 Ω
 S-video: DVD, VCR 1, VCR 2, VIDEO, TV SOUND/DBS:
 (Y: luminance): 1 V(p-p)/75 Ω
 (C: chrominance, burst): 0.286 V(p-p)/75 Ω

Component: COMPONENT 1(DVD) / COMPONENT 2:
 (Y: luminance): 1 V(p-p)/75 Ω
 (PB/CB, PR/CR): \pm 0.7 V/75 Ω

Video Output Level:

Composite video: VCR 1, VCR 2, MONITOR OUT: 1 V(p-p)/75 Ω
 S-video: VCR 1, VCR 2, MONITOR OUT:
 (Y: luminance): 1 V(p-p)/75 Ω
 (C: chrominance, burst): 0.286 V(p-p)/75 Ω
 Component: MONITOR OUT
 (Y: luminance): 1 V(p-p)/75 Ω
 (PB/CB, PR/CR): \pm 0.7 V/75 Ω

Synchronization:

Negative

Signal-to-Noise Ratio:

45 dB

Continued on the next page.

FM tuner (IHF)

Tuning Range:		87.5 MHz to 108.0 MHz
Usable Sensitivity:	Monaural:	12.8 dBf (1.2 μ V/75 Ω)
50 dB Quieting Sensitivity:	Monaural:	18.2 dBf (2.2 μ V/75 Ω)
	Stereo:	38.2 dBf (22.3 μ V/75 Ω)
Signal-to-Noise Ratio (IHF-A weighted):	Monaural:	78 dB at 85 dBf
	Stereo:	73 dB at 85 dBf
Total Harmonic Distortion:	Monaural:	0.2% at 1 kHz
	Stereo:	0.3% at 1 kHz
Stereo Separation at REC OUT:		40 dB at 1 kHz
Alternate Channel Selectivity:		60 dB (\pm 400 kHz)
Frequency Response:		30 Hz to 15 kHz (+0.5 dB, -3 dB)

AM tuner

Tuning Range:		530 kHz to 1 710 kHz
Usable Sensitivity:	Loop antenna:	400 μ V/m
Signal-to-Noise Ratio:		50 dB (100 mV/m)

General

Power Requirements:		AC 120V \sim , 60 Hz
Power Consumption:		485 W/615 VA (at operation) 2.6 watts (in standby mode)
Dimensions (W x H x D):		445 mm x 177 mm x 475 mm (17 ⁹ / ₁₆ in. x 7 in. x 18 ³ / ₄ in.)
Mass:		22.0 kg (49 lbs)

Designs & specifications are subject to change without notice.

Authorized Service Centers

QUALITY **JVC**[®] SERVICE

HOW TO LOCATE YOUR JVC SERVICE CENTER

TOLL FREE: 1 (800) 537-5722

<http://www.jvc.com>

Dear Customer,

In order to receive the most satisfaction from your purchase, please read the instruction booklet before operating the unit. In the event that repairs are necessary, please call 1 (800)537-5722 for your nearest authorized servicer or visit our website at **www.JVC.com**

Remember to retain your Bill of Sale for Warranty Service.

Do not service the television yourself

Caution

To prevent electrical shock, do not open the cabinet. There are no user serviceable parts inside. Please refer to qualified service personnel for repairs.

Accessories

To purchase accessories for your JVC product, please call toll free: 1 (800)882-2345 or on the web at **www.JVC.com**



LIMITED WARRANTY

AUDIO-2

JVC COMPANY OF AMERICA warrants this product and all parts thereof, except as set forth below ONLY TO THE ORIGINAL PURCHASER AT RETAIL to be FREE FROM DEFECTIVE MATERIALS AND WORKMANSHIP from the date of original retail purchase for the period as shown below. ("The Warranty Period")

PARTS	2 YRS	LABOR	2 YRS
-------	--------------	-------	--------------

THIS LIMITED WARRANTY IS VALID ONLY IN THE FIFTY (50) UNITED STATES, THE DISTRICT OF COLUMBIA AND IN COMMONWEALTH OF PUERTO RICO.

WHAT WE WILL DO:

If this product is found to be defective, JVC will repair or replace defective parts at no charge to the original owner. Such repair and replacement services shall be rendered by JVC during normal business hours at JVC authorized service centers. Parts used for replacement are warranted only for the remainder of the Warranty Period. All products and parts thereof may be brought to a JVC authorized service center on a carry-in basis except for Television sets having a screen size 25 inches and above which are covered on an in-home basis.

WHAT YOU MUST DO FOR WARRANTY SERVICE:

Return your product to a JVC authorized service center with a copy of your bill of sale. For your nearest JVC authorized service center, please call toll free: (800) 537-5722.

If service is not available locally, box the product carefully, preferably in the original carton, and ship, insured, with a copy of your bill of sale plus a letter of explanation of the problem to the nearest JVC Factory Service Center, the name and location of which will be given to you by the toll-free number.

If you have any questions concerning your JVC Product, please contact our Customer Relations Department.

WHAT IS NOT COVERED:

This limited warranty provided by JVC does not cover:

1. Products which have been subject to abuse, accident, alteration, modification, tampering, negligence, misuse, faulty installation, lack of reasonable care, or if repaired or serviced by anyone other than a service facility authorized by JVC to render such service, or if affixed to any attachment not provided with the products, or if the model number or serial number has been altered, tampered with, defaced or removed;
2. Initial installation and installation and removal for repair;
3. Operational adjustments covered in the Owner's Manual, normal maintenance, video and audio head cleaning;
4. Damage that occurs in shipment, due to act of God, and cosmetic damage;
5. Signal reception problems and failures due to line power surge;
6. Video Pick-up Tubes/CCD Image Sensor, Cartridge, Stylus (Needle) are covered for 90 days from the date of purchase;
7. Batteries (except that Rechargeable Batteries are covered for 90 days from the date of purchase);

There are no express warranties except as listed above.

THE DURATION OF ANY IMPLIED WARRANTIES, INCLUDING THE IMPLIED WARRANTY OF MERCHANTABILITY, IS LIMITED TO THE DURATION OF THE EXPRESS WARRANTY HEREIN.

JVC SHALL NOT BE LIABLE FOR THE LOSS OF USE OF THE PRODUCT, INCONVENIENCE, LOSS OR ANY OTHER DAMAGES, WHETHER DIRECT, INCIDENTAL OR CONSEQUENTIAL (INCLUDING, WITHOUT LIMITATION, DAMAGE TO TAPES, RECORDS OR DISCS) RESULTING FROM THE USE OF THIS PRODUCT, OR ARISING OUT OF ANY BREACH OF THIS WARRANTY. ALL EXPRESS AND IMPLIED WARRANTIES, INCLUDING THE WARRANTIES OF MERCHANTABILITY AND FITNESS FOR PARTICULAR PURPOSE, ARE LIMITED TO THE WARRANTY PERIOD SET FORTH ABOVE.

Some states do not allow the exclusion of incidental or consequential damages or limitations on how long an implied warranty lasts, so these limitations or exclusions may not apply to you. This warranty gives you specific legal rights and you may also have other rights which vary from state to state.

JVC COMPANY OF AMERICA
DIVISION OF JVC AMERICAS CORP.

1700 Valley Road
Wayne, NJ 07470

REFURBISHED PRODUCTS CARRY A SEPARATE WARRANTY, THIS WARRANTY DOES NOT APPLY. FOR DETAILS OF REFURBISHED PRODUCT WARRANTY, PLEASE REFER TO THE REFURBISHED PRODUCT WARRANTY INFORMATION PACKAGED WITH EACH REFURBISHED PRODUCT.

For customer use:

Enter below the Model No. which is located either on the rear, bottom or side of the cabinet. Retain this information for future reference.

Model No. : _____

Serial No. : _____

Purchase data : _____

Name of dealer : _____

